

CTNCA 

NovaArquitectura & arquitectos



TÉCNICO · TECHNICAL

CTNCA 

TÉCNICO · TECHNICAL



TECHNIQUE · TECHNISCHE

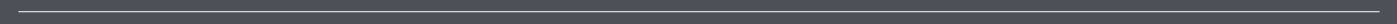

ÍNDICE

CTINCA 

NovaArquitectura

LADRILHOS VIDRADOS INGELIVOS ACETINADOS · SATIN FINISH FROST RESISTANT GLAZED STONEWARE TILES
CARREAUX INGÉLIFS EN GRÈS FIN VITRIFIÉ, ÉMAILLÉ, SATINÉ · FROSTSICHERE, GLASIERTE STEINZEUGFLIESE IN SEIDENMATT



PRÉ-CORTADO · PRE-FORMED
PRÉ-COUPÉ · RASTERFUGE



ANTIDERRAPANTE · ANTI-SLIP
ANTIDÉRAPANT · TRITTSICHER



PEÇAS ESPECIAIS · TRIM PIECES
PIÈCES SPÉCIALES · FORMSTÜCKE

20

arquitectos

AZULEJOS DE PASTA BRANCA BICOZEDURA BRILHANTE/MATE · GLOSSY/MATT DOUBLE FIRED WHITE BODY WALL TILES
FAÏENCES EN PÂTE BLANCHE BI-CUISSON BRILLANT/MAT · WEISS-SCHERBIGE ZWEIBRAND STEINGUTFLIESEN GLÄNZEND/MATT



PEÇAS ESPECIAIS · TRIM PIECES
PIÈCES SPÉCIALES · FORMSTÜCKE

34

PIANO LISTÉIS · BORDERS
LISTELS · BORDÜREN



NovaArquitectura

LADRILHOS VIDRADOS INGELIVOS ACETINADOS · SATIN FINISH FROST RESISTANT GLAZED STONEWARE TILES
 CARREAUX INGÉLIFS EN GRÈS FIN VITRIFIÉ, ÉMAILLÉ, SATINÉ · FROSTSICHERE, GLASIERTE STEINZEUGFLIESE IN SEIDENMATT

M 60×60 cm
 24"×24"
 W 597×597×10 mm



M 30×30 cm
 12"×12"
 W 297×297×7 mm



M 10×30 cm
 4"×12"
 W 97×297×7 mm



M 20×20 cm
 8"×8"
 W 197×197×6 mm



M 10×20 cm
 4"×8"
 W 97×197×6 mm



M 15×15 cm
 6"×6"
 W 147×147×6 mm



M 10×10 cm
 4"×4"
 W 97×97×6 mm



APLICAÇÃO · APPLICATION · APPLICATION · VERLEGUNG
 ACABAMENTO · FINISH · FINITION · OBERFLÄCHE



LADRILHOS VIDRADOS INGELIVOS
 FROST RESISTANT GLAZED STONEWARE TILES

EN 14411: 2012 ANNEX H GROUP BI_b GL
 ISO 13006: 2012 ANNEX H GROUP BI_b GL
 ANSI A137.1-2012 CLASS P2 (VITREOUS)

54 CORES
 54 COLOURS

ACETINADO
 SATIN FINISH

07 FORMATOS
 07 FORMATS

MODULAR
 MODULAR

CARREAUX INGÉLIFS EN GRÈS FIN VITRIFIÉ, ÉMAILLÉ
 FROSTSICHERE, GLASIERTE STEINZEUGFLIESE

EN 14411: 2012 ANNEX H GROUP BI_b GL
 ISO 13006: 2012 ANNEX H GROUP BI_b GL
 ANSI A137.1-2012 CLASS P2 (VITREOUS)

54 COLORIS
 54 FARBEN

SATINÉ
 SEIDENMATT

07 FORMATS
 07 FORMATE

MODULAIRE
 MODUL



NovaArquitectura

LADRILHOS VIDRADOS INGELIVOS ACETINADOS · SATIN FINISH FROST RESISTANT GLAZED STONEWARE TILES
 CARREAUX INGÉLIFS EN GRÈS FIN VITRIFIÉ, ÉMAILLÉ, SATINÉ · FROSTSICHERE, GLASIERTE STEINZEUGFLIESE IN SEIDENMATT
 EN 14411: 2012 ANNEX H GROUP B16 GL · ISO 13006:2012 ANNEX H GROUP B16 GL · ANSI A137.1-2012 CLASS P2 (VITREOUS)



Todos os artigos com a referência sublinhada estão disponíveis em revestimento coordenado (consultar pág. 26 a 33) e os artigos com * existem apenas no formato M20x20 cm.

All items where the product code is underlined have a matching wall tile (see pages 26 to 33). Items marked with an * are only available in size M20x20 cm.

Tous les articles soulignés sont disponibles en faïence coordonnée (consulter de la page 26 à 33), et les articles signalés * n'existent qu'en format M20x20 cm.

Die unterstrichenen Artikelnummern sind auch als kombinierbare Wandfliesen erhältlich (siehe Seite 26 bis 33). Die Artikel mit * gibt es nur im Format M20x20 cm.



Este produto também se encontra disponível em ladrilho de porcelanato vidrado ingelivo acetinado.

This product is also available in Glazed Porcelain.

Ce produit peut être fourni également en grès cérame fin vitrifié ingélif, émaillé, satiné.

Dieser Artikel ist auch als frostsicheres, glasiertes Feinsteinzeug in seidenmatt erhältlich.

EN 14411:2012 Annex G Group B1a GL
 ISO 13006:2012 Annex G Group B1a GL
 ANSI A137.1-2012 Class P1 (Impervious - Porcelain)

02 FORMATOS · 02 FORMATS
 02 FORMATS · 02 FORMATE

M20x20 cm
 8" x 8"
 W 197 x 197 x 6 mm

M 10x20 cm
 4" x 8"
 W 97 x 197 x 6 mm



Formato · Format	Caixa · Box			Paleta · Pallet				
	Pcs. · Stk.	m²	kg	Caixa / Paleta Box / Pallet	m²	Net. kg	Brut. kg	cm
Pavimento · Floor Tiles Carreaux de Sol · Bodenfliese	M20x20x0,6 cm M10x20x0,6 cm	25 50	1,00 1,00	12,64 12,77	84 84	1.062 1.073	1.087 1.098	120x80x73 120x80x74



54 CORES · 54 COLOURS
 54 COLORIS · 54 FARBEN

Cores disponíveis em stock · Colours available in stock
 Coloris disponibles en stock · Farben sind Lagerware

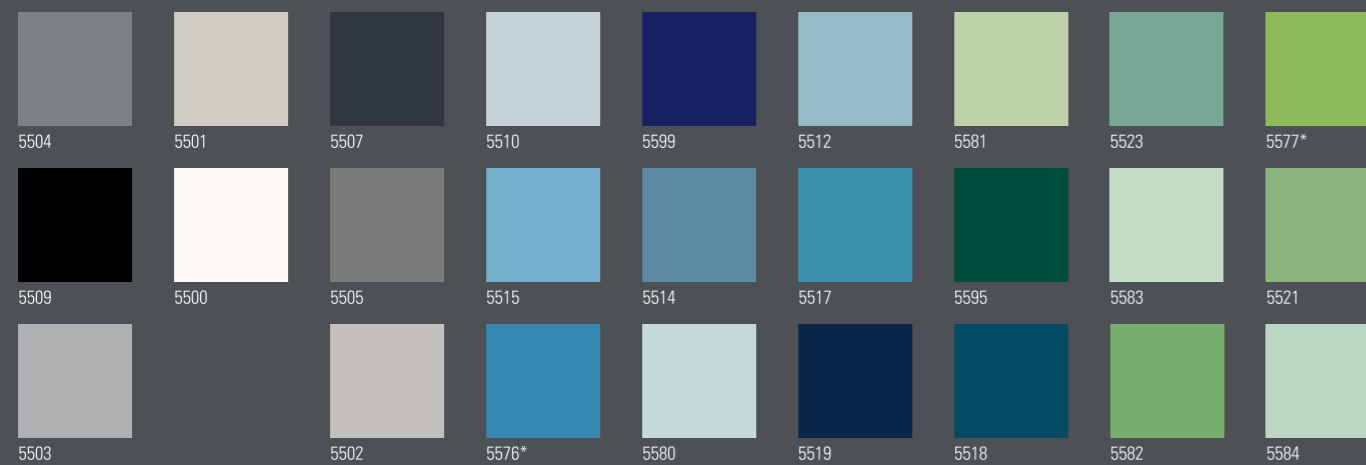

branco white
 cinza pérola pearl grey
 cinza prata silver grey
 cinza aço steel grey
 cinza chumbo lead grey
 cinza profundo deep grey
 cinza antracite anthracite grey
 preto black
 azul china china blue
 cobalto cobalt
 azul petróleo petrol blue
 azul atlas atlas blue
 azul eléctrico electric blue
 azul leguna lagoon blue
 azul caribe caribbean blue
 azul celeste sky blue
 azul cristal crystal blue
 azul gelo ice blue
 verde aqua water green
 jade jade
 verde menta mint green
 verde wasabi wasabi green
 verde maio may green
 verde prado field green
 verde mar sea green
 verde victoriano victorian green
 mocha mocha

conhaque cognac
 camel camel
 sândalo sandal
 bege beige
 curry curry
 mostarda mustard
 bege bahamas bahamas beige
 bege calahari kalahari beige
 areia sand
 jasmim jasmine
 baunilha vanilla
 amarelo palha straw yellow
 amarelo índio indian yellow
 amarelo yellow
 amarelo ouro gold yellow
 âmbar amber
 tangerina tangerine
 salmão salmon
 coral coral
 carmim carmine
 burgundy burgundy
 amarantha amaranth
 púrpura purple
 orquídea orchid
 rosa aurora aurora rose
 rosa champagne champagne rose
 rosa coralino coral pink

NovaArquitectura

LADRILHOS VIDRADOS INGELIVOS ACETINADOS · SATIN FINISH FROST RESISTANT GLAZED STONEWARE TILES
 CARREAUX INGÉLIFS EN GRÈS FIN VITRIFIÉ, ÉMAILLÉ, SATINÉ · FROSTSICHERE, GLASIERTE STEINZEUGFLIESE IN SEIDENMATT
 EN 14411: 2012 ANNEX H GROUP B16 GL · ISO 13006:2012 ANNEX H GROUP B16 GL · ANSI A137.1-2012 CLASS P2 (VITREOUS)



Todos os artigos com a referência sublinhada estão disponíveis em revestimento coordenado (consultar pág. 26 a 33).

All items where the product code is underlined have a matching wall tile (see pages 26 to 33).

Tous les articles soulignés disposent d'un revêtement coordonné (consulter de la page 26 à 33).

Die unterstrichenen Artikelnummern sind auch als kombinierbare Wandfliesen erhältlich (siehe Seite 26 bis 33).



Este produto também se encontra disponível em ladrilho de porcelanato vidrado ingelivo acetinado.

This product is also available in Glazed Porcelain.

Ce produit peut être fourni également en grès cérame fin vitrifié ingélif, émaillé, satiné.

Dieser Artikel ist auch als frostsicheres, glasiertes Feinsteinzeug in seidenmatt erhältlich.

EN 14411:2012 Annex G Group B1a GL
 ISO 13006:2012 Annex G Group B1a GL
 ANSI A137.1-2012 Class P1 (Impervious - Porcelain)

Formato · Format	Caixa · Box			Paleta · Pallet					
	Pcs. · Stk.	m²	kg	Caixa / Paleta Box / Pallet	m²	Net. kg	Brut. kg	cm	
Pavimento · Floor Tiles Carreaux de Sol · Bodenfliese	M60×60×1 cm	3	1,08	24,30	36	38,88	875	900	120×80×74
	M30×30×0,7 cm	15	1,35	20,15	50	67,50	1.008	1.033	120×80×73
	M10×30×0,7 cm	50	1,50	21,80	48	72,00	1.046	1.071	120×80×73
	M15×15×0,6 cm	44	1,00	12,34	80	80,00	987	1.012	120×80×73

04 FORMATOS · 04 FORMATS
 04 FORMATS · 04 FORMATE

M60×60 cm
 24"×24"
 W 597×597×10 mm

M30×30 cm
 12"×12"
 W 297×297×7 mm

M10×30 cm
 4"×12"
 W 97×297×7 mm

M15×15 cm
 6"×6"
 W 147×147×6 mm



27 CORES · 27 COLOURS
 27 COLORIS · 27 FARBEN

Cores disponíveis em stock · Colours available in stock
 Coloris disponibles en stock · Farben sind Lagerware

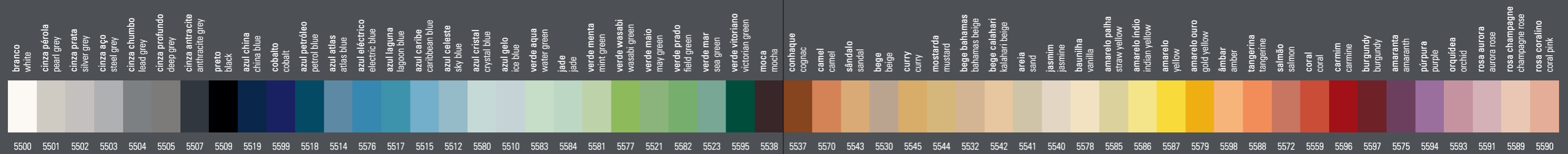
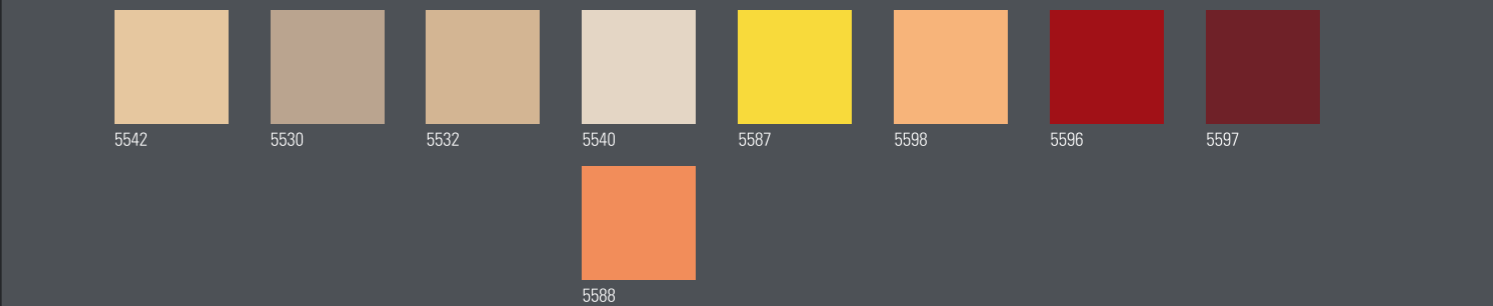
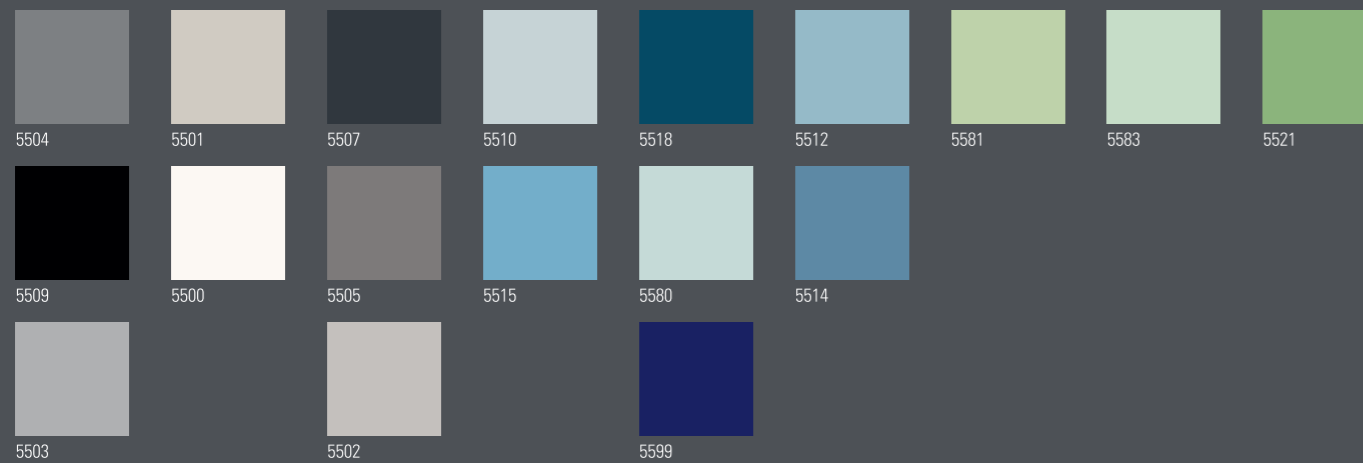

NovaArquitectura

LADRILHOS VIDRADOS INGELIVOS ACETINADOS · SATIN FINISH FROST RESISTANT GLAZED STONEWARE TILES
 CARREAUX INGÉLIFS EN GRÈS FIN VITRIFIÉ, ÉMAILLÉ, SATINÉ · FROSTSICHERE, GLASIERTE STEINZEUGFLIESE IN SEIDENMATT
 EN 14411: 2012 ANNEX H GROUP B16 GL · ISO 13006:2012 ANNEX H GROUP B16 GL · ANSI A137.1-2012 CLASS P2 (VITREOUS)



Produto colado em papel perfurado. Placas de aproximadamente 30x30 cm, 3x3 peças. Todos os artigos com a referência sublinhada estão disponíveis em revestimento coordenado (consultar pág. 26 a 33).

Product glued on paper mesh. Sheets of approximately 30x30 cm, 3x3 pieces. All items where the product code is underlined have a matching wall tile (see pages 26 to 33).

Produit collé sur papier perforé. Plaques d'environ 30x30 cm, 3x3 pièces. Tous les articles soulignés disposent d'un revêtement coordonné (consulter de la page 26 à 33).

Artikel geklebt auf Netzpapier, Matten ca. 30x30 cm, 3x3 Stück. Die unterstrichenen Artikelnummern sind auch als kombinierbare Wandfliesen erhältlich (siehe Seite 26 bis 33).



Este produto também se encontra disponível em ladrilho de porcelanato vidrado ingelivo acetinado.

This product is also available in Glazed Porcelain.

Ce produit peut être fourni également en grès cérame fin vitrifié ingélif, émaillé, satiné.

Dieser Artikel ist auch als frostsicheres, glasiertes Feinsteinzeug in seidenmatt erhältlich.

EN 14411:2012 Annex G Group B1a GL
 ISO 13006:2012 Annex G Group B1a GL
 ANSI A137.1-2012 Class P1 (Impervious - Porcelain)

Formato · Format	Caixa · Box 			Paleta · Pallet 					
	Pcs. · Stk.	m²	kg	Caixa / Paleta Box / Pallet	m²	Net. kg	Brut. kg	cm	
Pavimento · Floor Tiles Carreaux de Sol · Bodenfliese	M10x10x0,6 cm	99	1,00	12,50	78	78,00	975	1.000	120x80x82

01 FORMATO · 01 FORMAT
 01 FORMAT · 01 FORMAT

M10x10 cm
 4" x 4"
 W 97x97x6 mm



11 CORES · 11 COLOURS
 11 COLORIS · 11 FARBEN

Cores disponíveis em stock · Colours available in stock
 Coloris disponibles en stock · Farben sind Lagerware

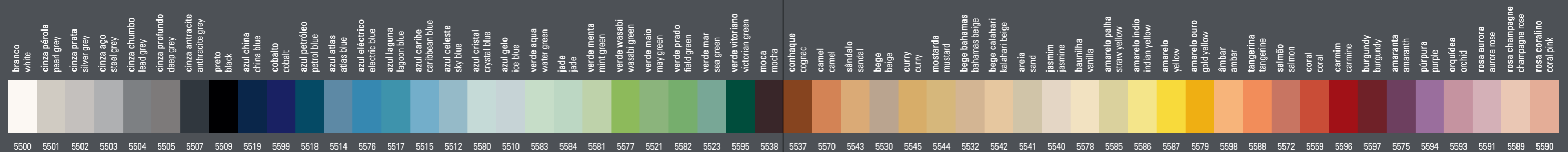
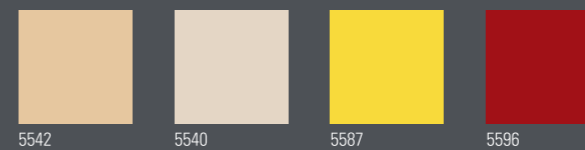
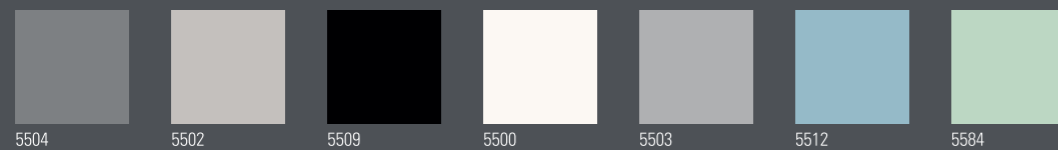

NovaArquitectura

PRÉ-CORTADO · PRE-FORMED · PRÉ-COUPÉ · RASTERFUGE

LADRILHOS VIDRADOS INGELIVOS ACETINADOS · SATIN FINISH FROST RESISTANT GLAZED STONEWARE TILES

CARREAUX INGÉLIFS EN GRÈS FIN VITRIFIÉ, ÉMAILLÉ, SATINÉ · FROSTSICHERE, GLASIERTE STEINZEUGFLIESE IN SEIDENMATT

EN 14411:2012 ANNEX H GROUP B1b GL · ISO 13006:2012 ANNEX H GROUP B1b GL · ANSI A137.1-2012 CLASS P2 (VITREOUS)



Para uma boa aplicação, a largura da junta deve ser igual à largura da junta das ranhuras. Todos os artigos com a referência sublinhada estão disponíveis em revestimento coordenado (consultar pág. 26 a 33).

In order to achieve a good application result, the width of the grout joint should be equal to the joints in the pre-formed tile.

All items where the product code is underlined have a matching wall tile (see pages 26 to 33).

Pour une application correcte, la largeur du joint doit être égale à la largeur du joint des rainures. Tous les articles soulignés disposent d'un revêtement coordonné (consultez la page 26 à 33).

Bei der Verlegung darauf achten, dass die Fuge die gleiche Größe hat wie die vorgefrägte Fuge. Die unterstrichenen Artikelnummern sind auch als kombinierbare Wandfliesen erhältlich (siehe Seite 26 bis 33).



Este produto também se encontra disponível em ladrilho de porcelanato vidrado ingelivo acetinado.

This product is also available in Glazed Porcelain.

Ce produit peut être fourni également en grès cérame fin vitrifié ingélif, émaillé, satiné.

Dieser Artikel ist auch als frostsicheres, glasiertes Feinsteinzeug in seidenmatt erhältlich.

EN 14411:2012 Annex G Group B1a GL
ISO 13006:2012 Annex G Group B1a GL
ANSI A137.1-2012 Class P1 (Impervious - Porcelain)

Formato · Format	Caixa · Box			Paleta · Pallet				
	Pcs. · Stk.	m ²	kg	Caixa / Paleta Box / Pallet	m ²	Net. kg	Brut. kg	cm
M20×20×0,6 cm	25	1,00	12,64	84	84,00	1.062	1.087	120×80×73

01 FORMATO · 06 SUB-FORMATOS · 01 SIZE · 06 SUB-SIZES

01 FORMAT · 06 SOUS-FORMATS · 01 FORMAT · 06 UNTERFORMATE

M20×20 cm
8"×8"

W 197×197×6 mm

10 × 10 cm
ref./10



5 × 20 cm
ref./520



5 × 10 cm
ref./510



5 × 5 cm
ref./5

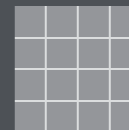

2,5 × 5 cm
ref./255



2,5 × 2,5 cm
ref./2,5

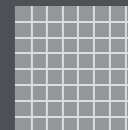

19 CORES · 19 COLOURS

19 COLORIS · 19 FARBEN

Cores disponíveis em stock · Colours available in stock

Coloris disponibles en stock · Farben sind Lagerware

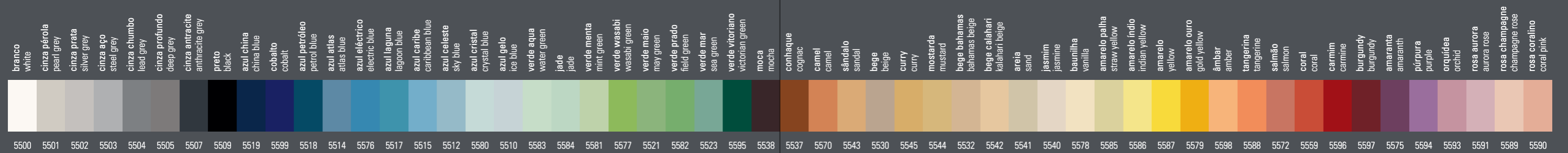
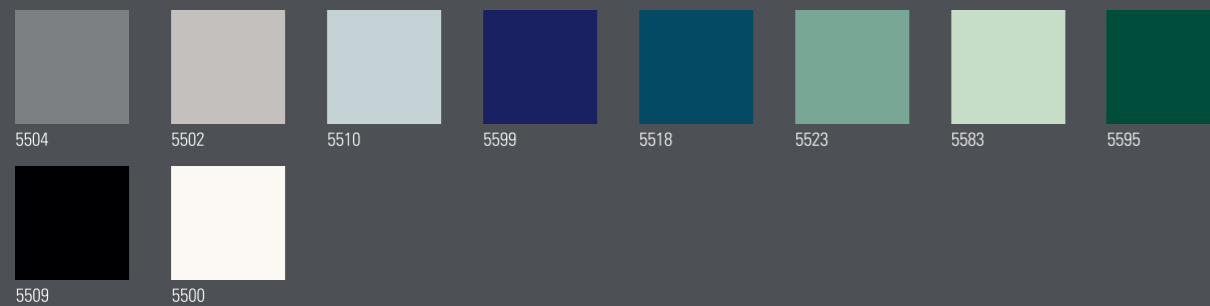



NovaArquitectura

ANTIDERRAPANTE · ANTI-SLIP · ANTIDÉRAPANTE · TRITTSICHER

LADRILHOS VIDRADOS INGELIVOS · FROST RESISTANT GLAZED STONEWARE TILES

CARREAUX INGÉLIFS EN GRÈS FIN VITRIFIÉ, ÉMAILLÉ · FROSTSICHERE, GLASIERTE STEINZEUGFLIESE

EN 14411: 2012 ANNEX H GROUP BIb GL · ISO 13006:2012 ANNEX H GROUP BIb GL · ANSI A137.1-2012 CLASS P2 (VITREOUS)



Todos os artigos com a referência sublinhada estão disponíveis em revestimento coordenado (consultar pág. 26 a 33).
* cores existentes no formato M 10×10 cm. Produto colado em papel perfurado. Placas de aproximadamente 30×30 cm, 3×3 peças.

All items where the product code is underlined have a matching wall tile (see pages 26 to 33).
* existing colours in format M 10×10 cm. Product glued on paper mesh. Sheets of approximately 30×30 cm, 3×3 pieces.

Tous les articles soulignés disposent d'un revêtement coordonné (consulter de la page 26 à 33).
* coloris existantes dans le format M 10×10 cm. Produit collé sur papier perforé. Plaques d'environ 30×30 cm, 3×3 pièces.

Die unterstrichenen Artikelnummern sind auch als kombinierbare Wandfliesen erhältlich (siehe Seite 26 bis 33).
* Farben erhältlich in M 10×10 cm. Artikel geklebt auf Netzpapier, Matten ca. 30×30 cm, 3×3 Stück.

NovaArquitectura
REF AD
55XX AD = 56XX

Formato · Format	Caixa · Box			Paleta · Pallet					
	Pcs. · Stk.	m ²	kg	Caixa / Paleta Box / Pallet	m ²	Net. kg	Brut. kg	cm	
Pavimento · Floor Tiles	M20×20×0,6 cm	25	1,00	12,64	84	84,00	1.062	1.087	120×80×73
Carreaux de Sol · Bodenfliese	M10×20×0,6 cm	50	1,00	12,77	84	84,00	1.073	1.098	120×80×74
	M10×10×0,6 cm	99	1,00	12,50	78	78,00	975	1.000	120×80×82

03 FORMATOS · 03 FORMATS

03 FORMATS · 03 FORMATE

M 20×20 cm AD
8"×8"
W 197×197×6 mm

M 10×20 cm AD
4"×8"
W 97×197×6 mm

M 10×10 cm AD
4"×4"
W 97×97×6 mm

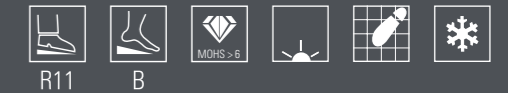

04 CORES · 04 COLOURS

04 COLORIS · 04 FARBEN

Cores disponíveis em stock · Colours available in stock

Coloris disponibles en stock · Farben sind Lagerware

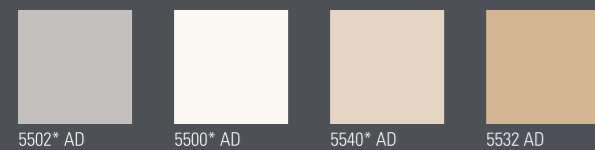

Este tipo de produto é requerido por razões de segurança e prevenção de acidente especialmente em áreas cuja função exija uma superfície resistente à derrapância. É indicado para condições húmidas e molhadas, em espaços públicos ou habitacionais. Recomendado para áreas de chuveiros e banheiros.

This product type is a requirement for areas where safety is of major importance. It provides an anti-slip surface which helps to prevent accidents. Recommended for humid or wet areas in public or residential areas: for example shower areas and dressing rooms.

Ce type de produit est requis pour des raisons de sécurité et prévention d'accidents, spécialement dans des endroits dont la fonction exige une surface résistante à l'antidérapance. Il est indiqué dans des conditions humides et mouillées, dans des espaces publics ou logements. Recommandé pour les douches et bains publics.

Dieser Produkttyp ist für Bereiche gedacht, in denen die Sicherheit von großer Bedeutung ist. Es bietet eine rutschfeste Oberfläche, die hilft, Unfälle zu vermeiden. Empfohlen für Feucht- und Nassbereiche in öffentlichen oder privaten Gebäuden, beispielsweise Duschbereiche und Umkleieräume.



Este produto também se encontra disponível em ladrilho de porcelanato vidrado ingelivo acetinado.

This product is also available in Glazed Porcelain.

Ce produit peut être fourni également en grès cérame fin vitrifié ingélif, émaillé, satiné.

Dieser Artikel ist auch als frostsichere, glasiertes Feinsteinzeug in seidenmatt erhältlich.

EN 14411:2012 Annex G Group BIa GL
ISO 13006:2012 Annex G Group BIa GL
ANSI A137.1-2012 Class P1 (Impervious - Porcelain)

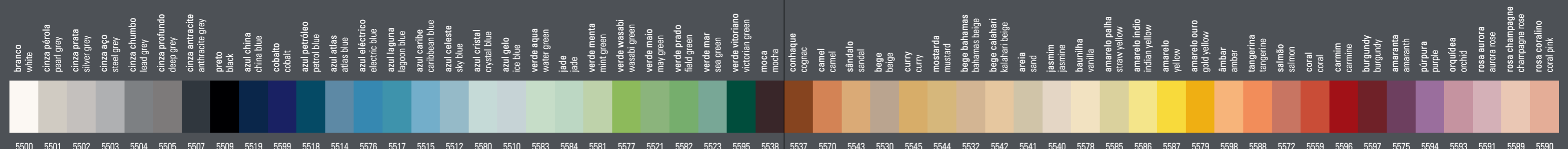

NovaArquitectura

ANTIDERRAPANTE · ANTI-SLIP · ANTIDÉRAPANTE · TRITTSICHER

LADRILHOS VIDRADOS INGELIVOS · FROST RESISTANT GLAZED STONEWARE TILES

CARREAUX INGÉLIFS EN GRÈS FIN VITRIFIÉ, ÉMAILLÉ · FROSTSICHERE, GLASIERTE STEINZEUGFLIESE

EN 14411: 2012 ANNEX H GROUP B1b GL · ISO 13006:2012 ANNEX H GROUP B1b GL · ANSI A137.1-2012 CLASS P2 (VITREOUS)



Todos os artigos com a referência sublinhada estão disponíveis em revestimento coordenado (consultar pág. 26 a 33).

All items where the product code is underlined have a matching wall tile (see pages 26 to 33).

Tous les articles soulignés disposent d'un revêtement coordonné (consulter de la page 26 à 33).

Die unterstrichenen Artikelnummern sind auch als kombinierbare Wandfliesen erhältlich (siehe Seite 26 bis 33).

NovaArquitectura
REF AD
55XX AD = 56XX

Formato · Format	Caixa · Box			Paleta · Pallet				
	Pcs. · Stk.	m²	kg	Caixa / Paleta Box / Pallet	m²	Net. kg	Brut. kg	cm
Pavimento · Floor Tiles Carreaux de Sol · Bodenfliese M 15×15×0,6 cm	44	1,00	12,34	80	80,00	987	1.012	120×80×73

01 FORMATO · 01 FORMAT

01 FORMAT · 01 FORMAT

M15×15cm AD

6"×6"

W 147×147×6mm

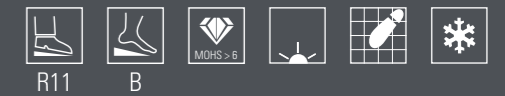

10 CORES · 10 COLOURS

10 COLORIS · 10 FARBEN

Cores disponíveis em stock · Colours available in stock

Coloris disponibles en stock · Farben sind Lagerware

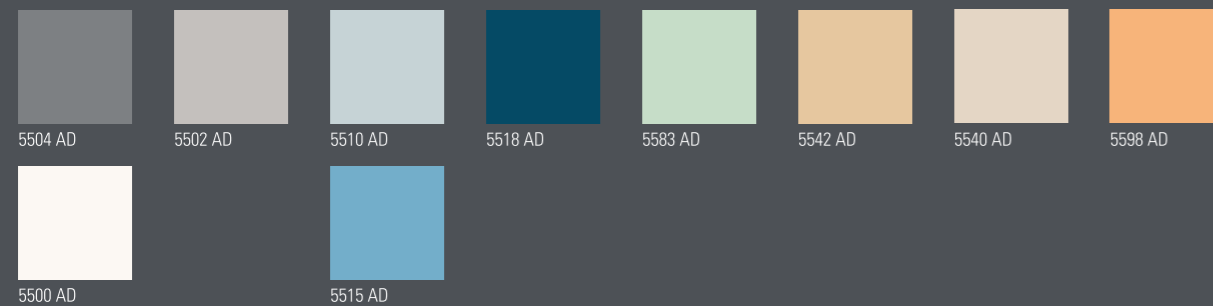

Este tipo de produto é requerido por razões de segurança e prevenção de acidente especialmente em áreas cuja função exija uma superfície resistente à derrapância. É indicado para condições húmidas e molhadas, em espaços públicos ou habitacionais. Recomendado para áreas de chuveiros e banheiros.

This product type is a requirement for areas where safety is of major importance. It provides an anti-slip surface which helps to prevent accidents. Recommended for humid or wet areas in public or residential areas: for example shower areas and dressing rooms.

Ce type de produit est requis pour des raisons de sécurité et prévention d'accidents, spécialement dans des endroits dont la fonction exige une surface résistante à l'antidérapance. Il est indiqué dans des conditions humides et mouillées, dans des espaces publics ou logements. Recommandé pour les douches et bains publics.

Dieser Produkttyp ist für Bereiche gedacht, in denen die Sicherheit von großer Bedeutung ist. Es bietet eine rutschfeste Oberfläche, die hilft, Unfälle zu vermeiden. Empfohlen für Feucht- und Nassbereiche in öffentlichen oder privaten Gebäuden, beispielsweise Duschbereiche und Umkleieräume.



Este produto também se encontra disponível em ladrilho de porcelanato vidrado ingelivo acetinado.

This product is also available in Glazed Porcelain.

Ce produit peut être fourni également en grès cérame fin vitrifié ingélif, émaillé, satiné.

Dieser Artikel ist auch als frostsichere, glasiertes Feinsteinzeug in seidenmatt erhältlich.

EN 14411:2012 Annex G Group B1a GL
ISO 13006:2012 Annex G Group B1a GL
ANSI A137.1-2012 Class P1 (Impervious - Porcelain)

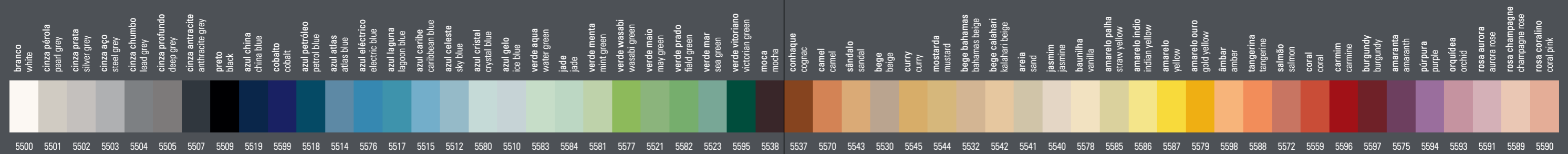

NovaArquitectura

PEÇAS ESPECIAIS · TRIM PIECES · PIÈCES SPÉCIALES · FORMSTÜCKE

LADRILHOS VIDRADOS INGELIVOS ACETINADOS · SATIN FINISH FROST RESISTANT GLAZED STONEWARE TILES

CARREAUX INGÉLIFS EN GRÈS FIN VITRIFIÉ, ÉMAILLÉ, SATINÉ · FROSTSICHERE, GLASIERTE STEINZEUGFLIESE IN SEIDENMATT

EN 14411: 2012 ANNEX H GROUP BIb GL · ISO 13006:2012 ANNEX H GROUP BIb GL · ANSI A137.1-2012 CLASS P2 (VITREOUS)



Disponível em branco 5500. Para encomenda de outras cores por favor consultar o fabricante. Devido aos diferentes métodos de produção usados nas peças especiais existe a possibilidade de ocorrer ligeiras variações de cor.

Available in white 5500. For more information on other colours please contact manufacturer. Due to the methods used in production of tiles and mouldings, slight variations in colour may occur.

Disponible en blanc 5500. Veuillez consulter le fabricant pour d'autres coloris. De légères variations de couleur sont possibles dû aux différentes méthodes de production utilisées sur ces pièces spéciales.

Erhältlich in Farbe weiß 5500. Sollten Sie diese in einer anderen Farbe benötigen wenden Sie sich bitte an unser Verkaufsteam. Produktionsbedingt können leichte Farbunterschiede bzw. Farbabweichungen auftreten.

Formato · Format	Caixa · Box		
	Pcs. · Stk.	m ² / ML	kg
3×3AECX	4	-	0,10
3×3AICX	4	-	0,10
3×3AICV	4	-	0,10
3×3AE	4	-	0,10
10×3AE	4	-	0,30
10×3AI	4	-	0,20
15×3AI	4	-	0,40
15×3AE	4	-	0,40
15×3CV	25	-	1,88
15×3CX	25	-	1,88
20×3CV	25	-	2,25
20×3CX	25	-	2,25
10×20RC	10	2,00 ML	3,30
10×20B1G	50	1,00 m ²	13,50
10×20B1P	50	1,00 m ²	13,50
10×20B2E	50	1,00 m ²	13,50
10×20B2D	50	1,00 m ²	13,50
15×15RC	10	1,50 m ²	3,30
15×15B1L	44	1,00 m ²	12,80
20×20B1L	25	1,00 m ²	12,70
20×20B2L	25	1,00 m ²	12,70
8×60ROD	20	12,00 ML	21,40

Peças Especiais
Pièces Spéciales
Trim Pieces
Formstücke

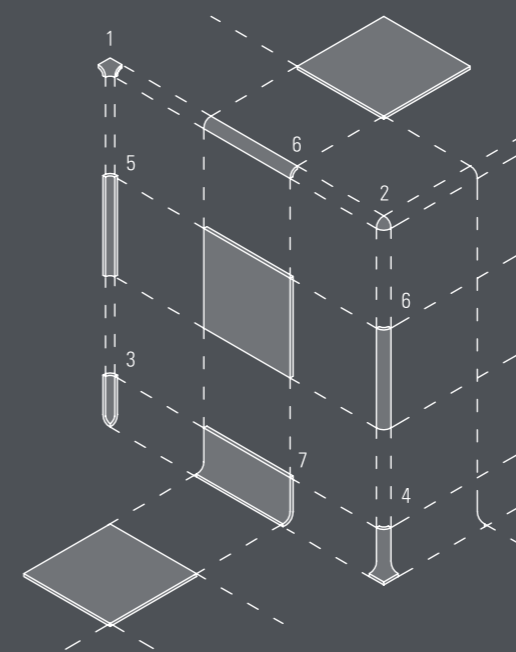
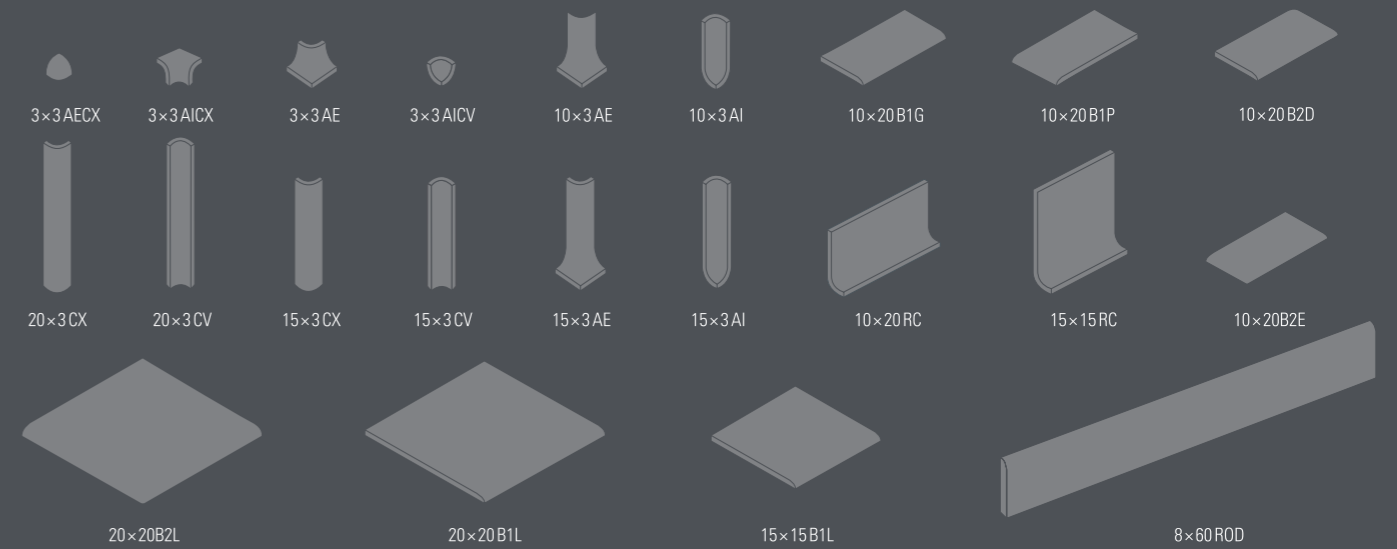
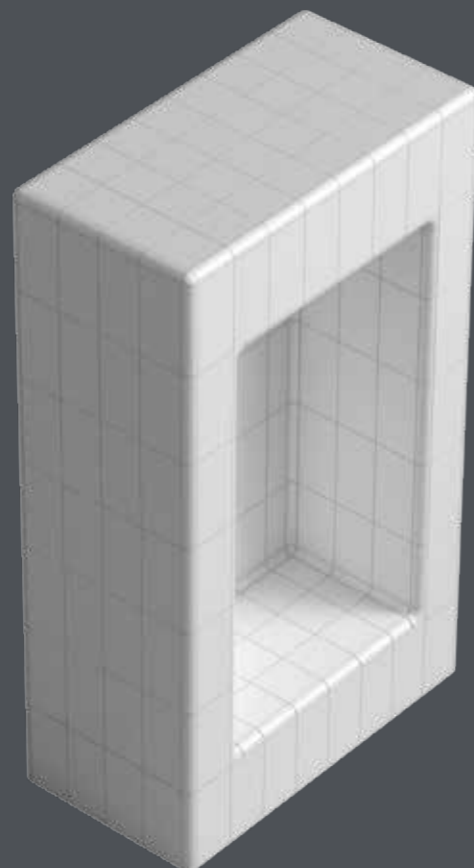

1 - 3×3 AICX · 2 - 3×3 AECX · 3 - 10×3 AI
4 - 10×3 AE · 5 - 20×3 CV · 6 - 20×3 CX · 7 - 10×20 RC

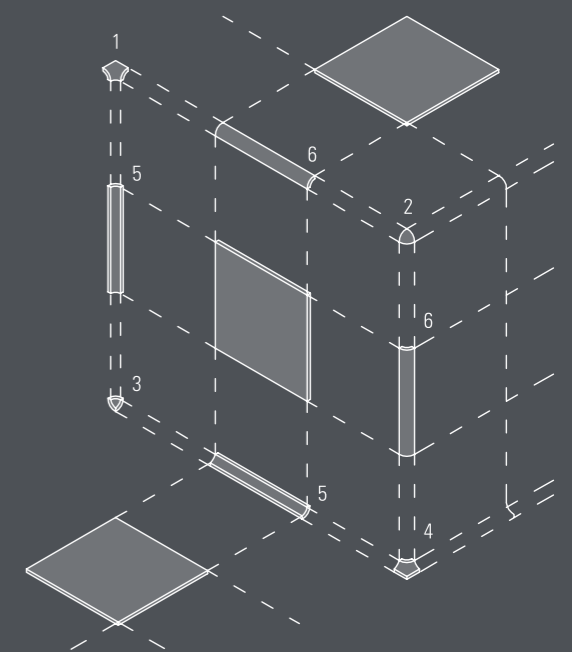

1 - 3×3 AICX · 2 - 3×3 AECX · 3 - 3×3 AICV
4 - 3×3 AE · 5 - 15×3 CV · 6 - 15×3 CX

NovaArquitectura

PEÇAS ESPECIAIS ANTIDERRAPANTES · TRIM PIECES WITH ANTI-SLIP FINISH

PIÈCES SPÉCIALES ANTIDÉRAPANTES · TRITTSICHERE FORMSTÜCKE

LADRILHOS VIDRADOS INGELIVOS ACETINADOS · SATIN FINISH FROST RESISTANT GLAZED STONEWARE TILES

CARREAUX INGÉLIFS EN GRÈS FIN VITRIFIÉ, ÉMAILLÉ, SATINÉ · FROSTSICHERE, GLASIERTE STEINZEUGFLIESE IN SEIDENMATT

EN 14411: 2012 ANNEX H GROUP B1b GL · ISO 13006:2012 ANNEX H GROUP B1b GL · ANSI A137.1-2012 CLASS P2 (VITREOUS)



Este tipo de produto é requerido por razões de segurança e prevenção de acidente especialmente em áreas cuja função exija uma superfície resistente à derrapância. É indicado para condições húmidas e molhadas, em espaços públicos ou habitacionais. Recomendado para áreas de chuveiros e balneários.

This product type is a requirement for areas where safety is of major importance. It provides an anti-slip surface which helps to prevent accidents. Recommended for humid or wet areas in public or residential areas: for example shower areas and dressing rooms.

Ce type de produit est requis pour des raisons de sécurité et prévention d'accidents, spécialement dans des endroits dont la fonction exige une surface résistante à l'antidérapance. Il est indiqué dans des conditions humides et mouillées, dans des espaces publiques ou logements. Recommandé pour les douches et bains publics.

Dieser Produkttyp ist für Bereiche gedacht, in denen die Sicherheit von großer Bedeutung ist. Es bietet eine rutschfeste Oberfläche, die hilft, Unfälle zu vermeiden. Empfohlen für Feucht- und Nassbereiche in öffentlichen oder privaten Gebäuden, beispielsweise Duschbereiche und Umkleieräume.



Disponível em branco 5500. Para encomenda de outras cores por favor consultar o fabricante. Devido aos diferentes métodos de produção usados nas peças especiais existe a possibilidade de ocorrer ligeiras variações de cor.

Available in white 5500. For more information on other colours please contact manufacturer. Due to the methods used in production of tiles and mouldings, slight variations in colour may occur.

Disponible en blanc 5500. Veuillez consulter le fabricant pour d'autres coloris. De légères variations de couleur sont possibles dû aux différentes méthodes de production utilisées sur ces pièces spéciales.

Erhältlich in Farbe weiß 5500. Sollten Sie diese in einer anderen Farbe benötigen wenden Sie sich bitte an unser Verkaufsteam. Produktionsbedingt können leichte Farbunterschiede bzw. Farbabweichungen auftreten.

Antiderrapante · Slip-resistant · Antidérapant · Trittsicher

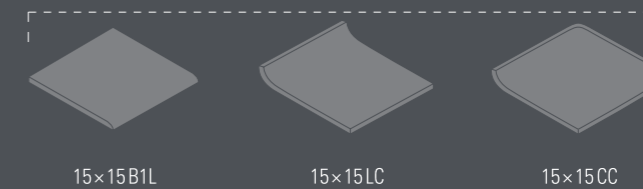

	Formato · Format	Caixa · Box		
		Pcs. · Stk.	m ²	kg
Peças Especiais	15×15B1L	44	1,00	12,80
Pièces Spéciales	15×15LC	10	1,50	3,30
Trim Pieces	15×15CC	4	-	1,50

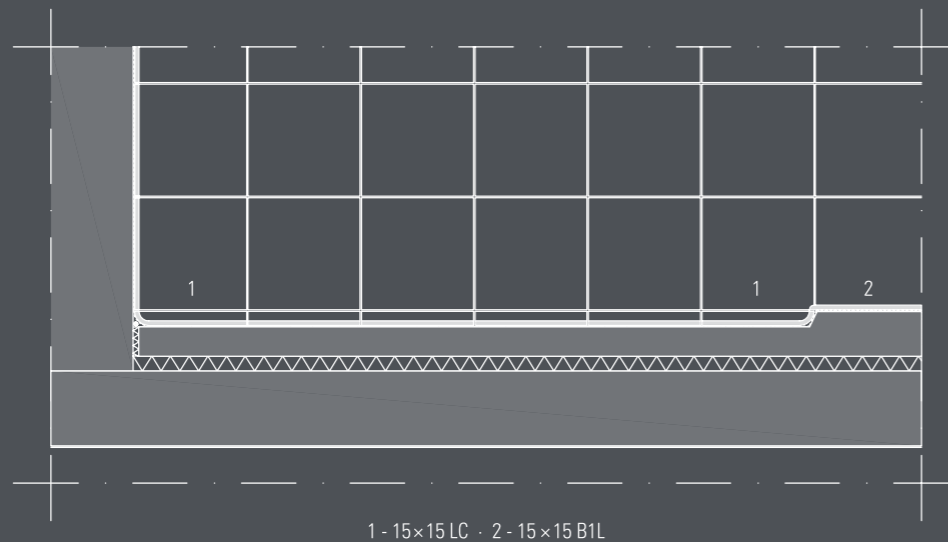

1 - 15×15 LC · 2 - 15×15 B1L

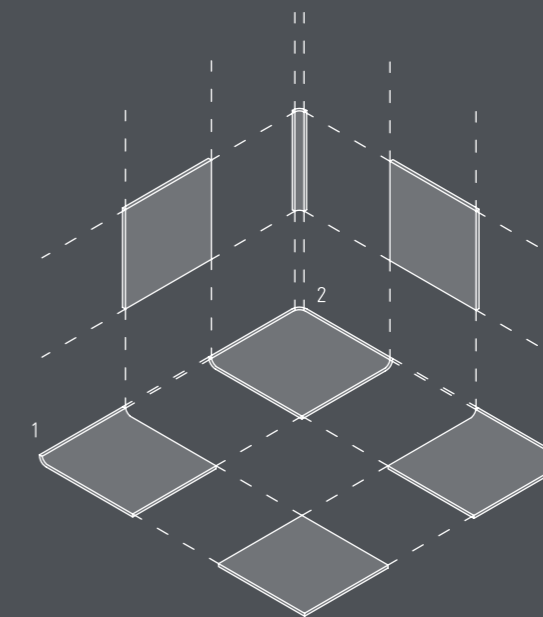

1 - 15×15 LC · 2 - 15×15 CC

arquitectos

AZULEJOS DE PASTA BRANCA BICOZEDURA BRILHANTE/MATE · GLOSSY/MATT DOUBLE FIRED WHITE BODY WALL TILES
FAÏENCES EN PÂTE BLANCHE BI-CUISSON BRILLANT/MAT · WEISS-SCHERBIGE ZWEIBRAND STEINGUTFLIESEN GLÄNZEND/MATT

M 20 × 40 cm
8" × 16"
W 197 × 397 × 7,5 mm

M 15 × 30 cm
6" × 12"
W 147 × 297 × 7,5 mm



APLICAÇÃO · APPLICATION · APPLICATION · VERLEGUNG
ACABAMENTO · FINISH · FINITION · OBERFLÄCHE

AZULEJOS DE PASTA BRANCA BICOZEDURA
DOUBLE FIRED WHITE BODY WALL TILES

EN 14411: 2012 ANNEX K GROUP BIII GL
ISO 13006: 2012 ANNEX L GROUP BIII GL
ANSI A134.1-2012 CLASS P4 (NON-VITREOUS)

57 CORES
57 COLOURS

02 ACABAMENTOS
02 FINISHES

04 FORMATOS
04 FORMATS

MODULAR
MODULAR

CTINCA 

M 20 × 20 cm
8" × 8"
W 197 × 197 × 7,5 mm

M 15 × 15 cm
6" × 6"
W 147 × 147 × 5,8 mm

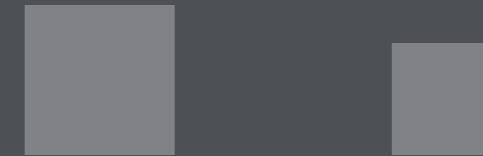

FAÏENCES EN PÂTE BLANCHE BI-CUISSON
WEISS-SCHERBIGE ZWEIBRAND STEINGUTFLIESEN

EN 14411: 2012 ANNEX K GROUP BIII GL
ISO 13006: 2012 ANNEX L GROUP BIII GL
ANSI A134.1-2012 CLASS P4 (NON-VITREOUS)

57 COLORIS
57 FARBEN

02 FINITIONS
02 OBERFLÄCHEN

04 FORMATS
04 FORMATE

MODULAIRE
MODUL



arquitectos

AZULEJOS DE PASTA BRANCA BICOZEDURA BRILHANTE · GLOSSY DOUBLE FIRED WHITE BODY WALL TILES
 FAÏENCES EN PÂTE BLANCHE BI-CUISSON BRILLANT · WEISS-SCHERBIGE ZWEIBRAND STEINGUTFLIESEN GLÄNZEND
 EN 14411: 2012 ANNEX K GROUP BIII GL · ISO 13006: 2012 ANNEX L GROUP BIII GL · ANSI A134.1-2012 CLASS P4 (NON-VITREOUS)



Todos os artigos com a referência sublinhada estão disponíveis em pavimento coordenado (consultar pág. 6 a 19).
 All items where the product code is underlined have a matching floor tile (see pages 6 to 19).
 Tous les articles soulignés disposent d'un sol coordonné (consulter de la page 6 à la 19).
 Die unterstrichenen Artikelnummern sind auch als kombinierbare Bodenfliesen erhältlich (siehe Seite 6 bis 19).

arquitectos	
REF Brancos · Whites · Blancs · Weiss	
M 20×20 cm	2200 = 0350
M 15×15 cm	2200 = 0001/147

Formato · Format	Caixa · Box			Paleta · Pallet					
	Pcs. · Stk.	m²	kg	Caixa / Paleta Box / Pallet	m²	Net. kg	Brut. kg	cm	
Revestimento · Wall Tiles Faïences · Wandfliese	M 20×20×0,75 cm M 15×15×0,58 cm	25 66	1,00 1,50	12,00 13,97	96 70	96,00 105,00	1.152 978	1.177 1.003	120×80×95 120×80×90

02 FORMATOS · 02 FORMATS
 02 FORMATS · 02 FORMATE

M 20×20 cm
 8"×8"
 W 197×197×7,5 mm

M 15×15 cm
 6"×6"
 W 147×147×5,8 mm

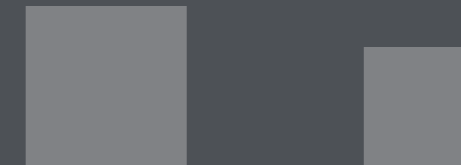

57 CORES · 57 COLOURS
 57 COLORIS · 57 FARBEN

Cores disponíveis em stock · Colours available in stock
 Coloris disponibles en stock · Farben sind Lagerware

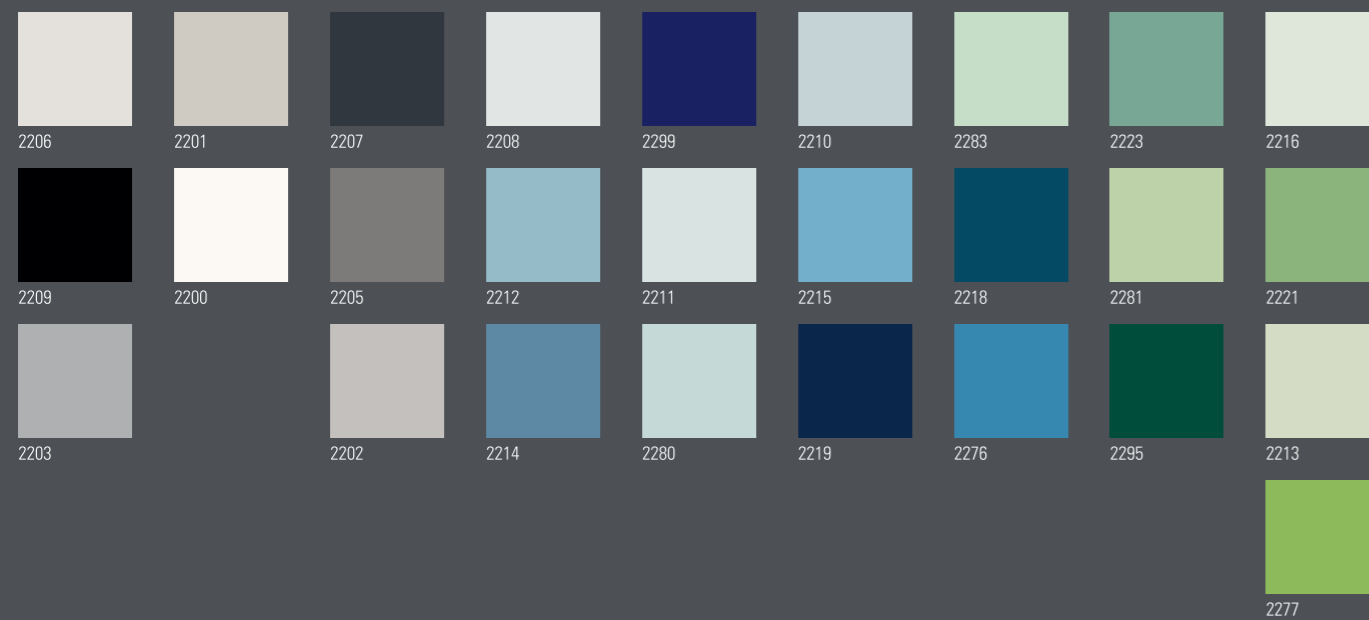

branco white
 cinza nuvem cloud grey
 cinza pérola pearl grey
 cinza prata silver grey
 cinza aço steel grey
 cinza profundo deep grey
 cinza antracite anthracite grey
 preto black
 azul china china blue
 cobalto cobalt
 azul petróleo petrol blue
 azul atlas atlas blue
 azul eléctrico electric blue
 azul caribe caribbean blue
 azul celeste sky blue
 azul cristal crystal blue
 azul gelo ice blue
 azul horizonte horizon blue
 azul azur
 verde oceano ocean green
 verde arcádia arcadia green
 verde aqua water green
 verde menta mint green
 verde wasabi wasabi green
 verde malo may green
 verde mar sea green
 verde victoriano victorian green
 mocha
 conhaque cognac
 camel
 sândalo sandal
 curry
 bege bahamas bahamas beige
 bege calahari kalahari beige
 areia sand
 marfim ivory
 pérola pearl
 creme cream
 jasmim jasmine
 frésia freesia
 baunilha vanilla
 amarelo índio indian yellow
 amarelo yellow
 amarelo ouro gold yellow
 âmbar amber
 tangerina tangerine
 salmão salmon
 coral coral
 carmim carmine
 burgundy burgundy
 amarantha amarant
 púrpura purple
 orquídea orchid
 rosa aurora aurora rose
 rosa pétala petal rose
 rosa baby baby pink
 rosa champagne champagne rose

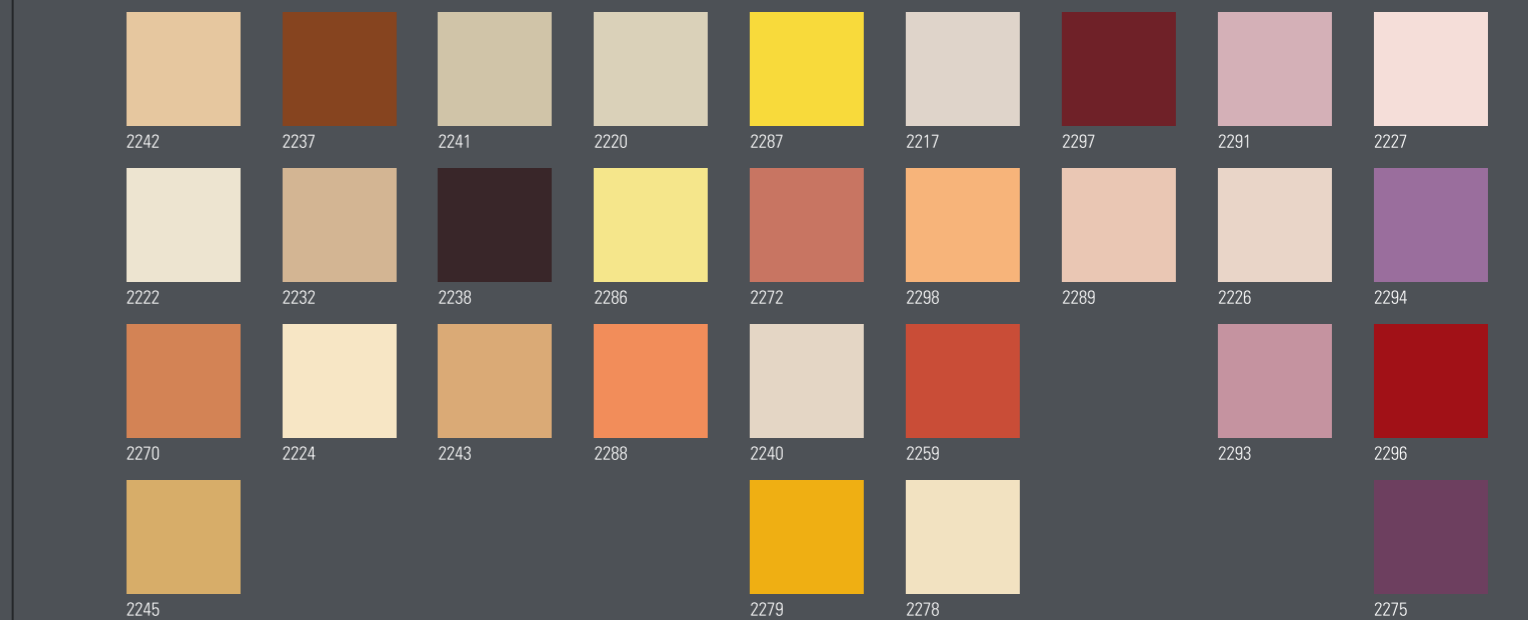

conhaque cognac
 camel
 sândalo sandal
 curry
 bege bahamas bahamas beige
 bege calahari kalahari beige
 areia sand
 marfim ivory
 pérola pearl
 creme cream
 jasmim jasmine
 frésia freesia
 baunilha vanilla
 amarelo índio indian yellow
 amarelo yellow
 amarelo ouro gold yellow
 âmbar amber
 tangerina tangerine
 salmão salmon
 coral coral
 carmim carmine
 burgundy burgundy
 amarantha amarant
 púrpura purple
 orquídea orchid
 rosa aurora aurora rose
 rosa pétala petal rose
 rosa baby baby pink
 rosa champagne champagne rose

arquitectos

AZULEJOS DE PASTA BRANCA BICOZEDURA MATE · MATT DOUBLE FIRED WHITE BODY WALL TILES
 FAÏENCES EN PÂTE BLANCHE BI-CUISSON MAT · WEISS-SCHERBIGE ZWEIBRAND STEINGUTFLIESEN MATT
 EN 14411: 2012 ANNEX K GROUP BIII GL · ISO 13006: 2012 ANNEX L GROUP BIII GL · ANSI A134.1-2012 CLASS P4 (NON-VITREOUS)



Todos os artigos com a referência sublinhada estão disponíveis em pavimento coordenado (consultar pág. 6 a 19).
 All items where the product code is underlined have a matching floor tile (see pages 6 to 19).
 Tous les articles soulignés disposent d'un sol coordonné (consulter de la page 6 à la 19).
 Die unterstrichenen Artikelnummern sind auch als kombinierbare Bodenfliesen erhältlich (siehe Seite 6 bis 19).

arquitectos	
REF Brancos · Whites · Blancs · Weiss	
M 20×20 cm	2300 = 0351
M 15×15 cm	2300 = 0151/147

Formato · Format	Caixa · Box			Paleta · Pallet					
	Pcs. · Stk.	m ²	kg	Caixa / Paleta Box / Pallet	m ²	Net. kg	Brut. kg	cm	
Revestimento · Wall Tiles Faïences · Wandfliese	M 20×20×0,75 cm M 15×15×0,58 cm	25 66	1,00 1,50	12,00 13,97	96 70	96,00 105,00	1.152 978	1.177 1.003	120×80×95 120×80×90

02 FORMATOS · 02 FORMATS
 02 FORMATS · 02 FORMATE

M 20×20 cm
 8"×8"
 W 197×197×7,5 mm

M 15×15 cm
 6"×6"
 W 147×147×5,8 mm



50 CORES · 50 COLOURS
 50 COLORIS · 50 FARBEN

Cores disponíveis em stock · Colours available in stock
 Coloris disponibles en stock · Farben sind Lagerware

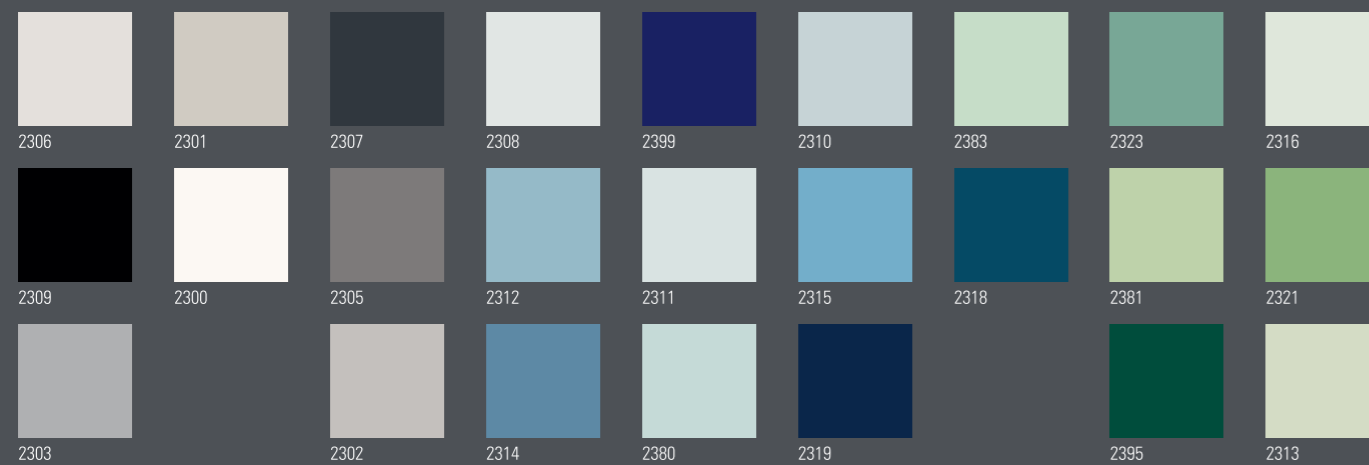

- branco white
- cinza nuvem cloud grey
- cinza pérola pearl grey
- cinza prata silver grey
- cinza aço steel grey
- cinza profundo deep grey
- cinza antracite anthracite grey
- preto black
- azul china china blue
- cobalto cobalt
- azul petróleo petrol blue
- azul atlas atlas blue
- azul eléctrico electric blue
- azul caribe caribbean blue
- azul celeste sky blue
- azul cristal crystal blue
- azul gelo ice blue
- azul horizonte horizon blue
- azul azul
- verde oceano ocean green
- verde arcádia arcadia green
- verde aqua water green
- verde menta mint green
- verde wasabi wasabi green
- verde malo may green
- verde mar sea green
- verde victoriano victorian green
- mocha

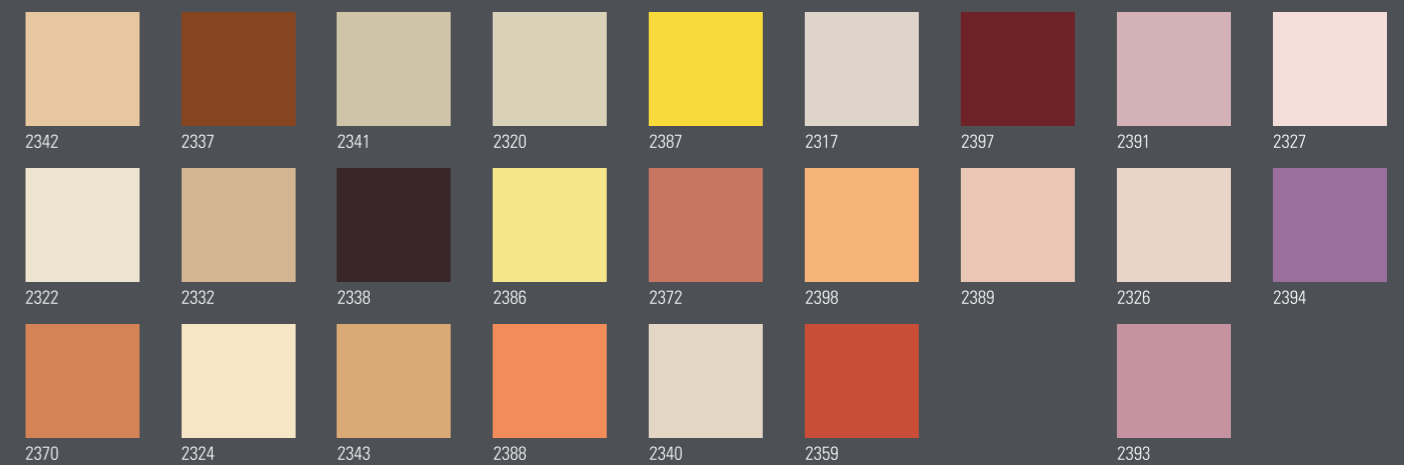

- conhaque cognac
- camel
- sândalo sandal
- curry
- bege bahamas bahamas beige
- bege calahari kalahari beige
- areia sand
- marfim ivory
- pérola pearl
- creme cream
- jasmin jasmine
- frésia freesia
- baunilha vanilla
- amarelo índio indian yellow
- amarelo yellow
- amarelo ouro gold yellow
- âmbar amber
- tangerina tangerine
- salimão salmon
- coral
- carmin carmine
- burgundy
- amaranta
- amarranth
- púrpura purple
- orquídea orchid
- rosa aurora
- rosa pétala petal rose
- rosa baby baby pink
- rosa champagne champagne rose

arquitectos

AZULEJOS DE PASTA BRANCA BICOZEDURA BRILHANTE · GLOSSY DOUBLE FIRED WHITE BODY WALL TILES
 FAÏENCES EN PÂTE BLANCHE BI-CUISSON BRILLANT · WEISS-SCHERBIGE ZWEIBRAND STEINGUTFLIESEN GLÄNZEND
 EN 14411: 2012 ANNEX K GROUP BIII GL · ISO 13006: 2012 ANNEX L GROUP BIII GL · ANSI A134.1-2012 CLASS P4 (NON-VITREOUS)



Todos os artigos com a referência sublinhada estão disponíveis em pavimento coordenado (consultar pág. 6 a 19).

All items where the product code is underlined have a matching floor tile (see pages 6 to 19).

Tous les articles soulignés disposent d'un sol coordonné (consulter de la page 6 à la 19).

Die unterstrichenen Artikelnummern sind auch als kombinierbare Bodenfliesen erhältlich (siehe Seite 6 bis 19).

arquitectos	
REF. Brancos · Whites · Blancs · Weiss	
M 20×40 cm	2200 = 0350
M 15×30 cm	

Formato · Format	Caixa · Box			Paleta · Pallet					
	Pcs. · Stk.	m ²	kg	Caixa / Paleta Box / Pallet	m ²	Net. kg	Brut. kg	cm	
Revestimento · Wall Tiles Faïences · Wandfliese	M 20×40×0,75 cm M 15×30×0,75 cm	25 26	2,00 1,17	24,00 14,48	48 70	96,00 81,90	1.152 1.014	1.177 1.039	120×80×96 120×80×91

02 FORMATOS · 02 FORMATS
02 FORMATS · 02 FORMATE

M 20×40 cm
8"×16"
W 197×397×7,5mm

M 15×30 cm
6"×12"
W 147×297×7,5mm



31 CORES · 31 COLOURS
31 COLORIS · 31 FARBEN

Cores disponíveis em stock · Colours available in stock
Coloris disponibles en stock · Farben sind Lagerware

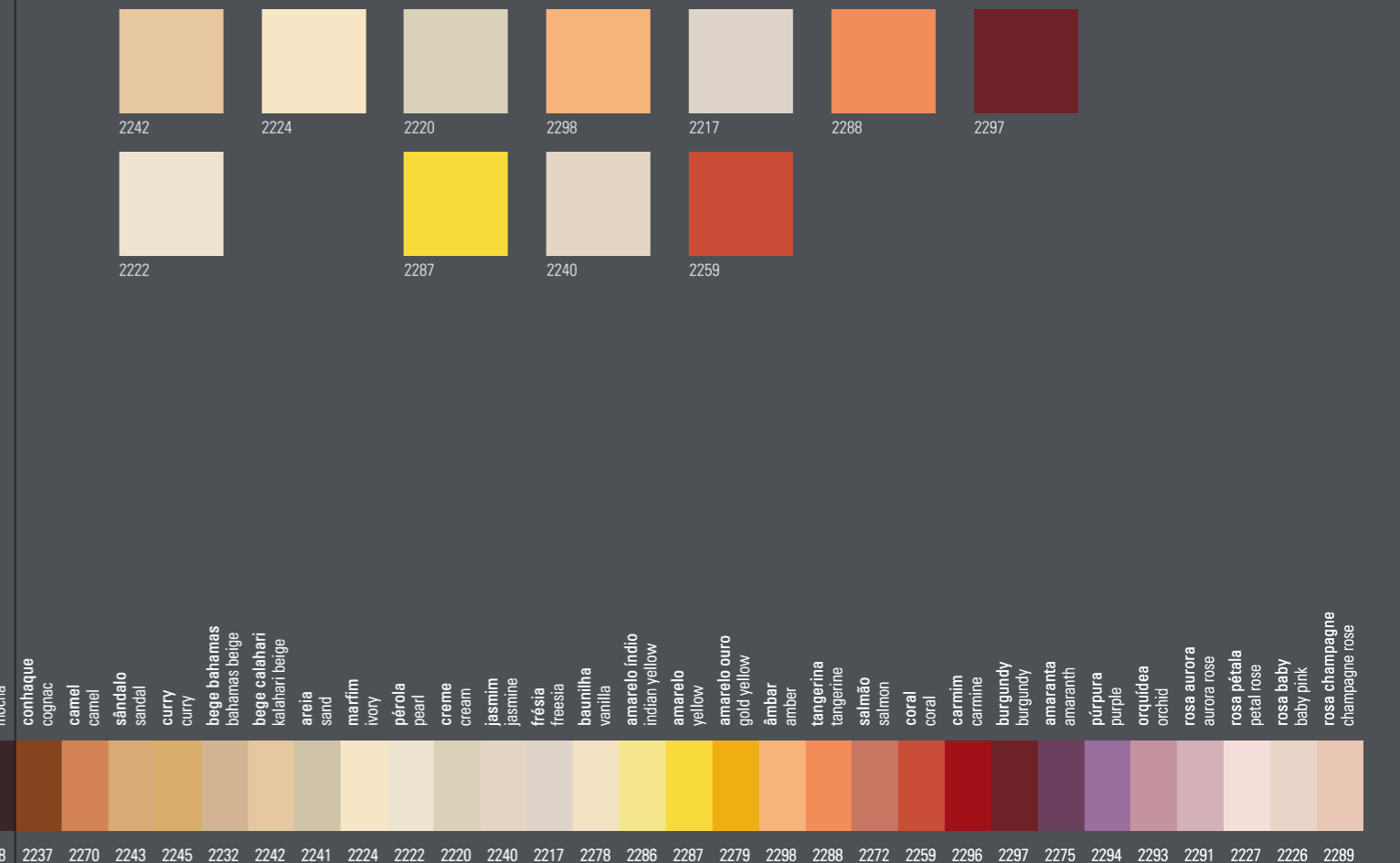
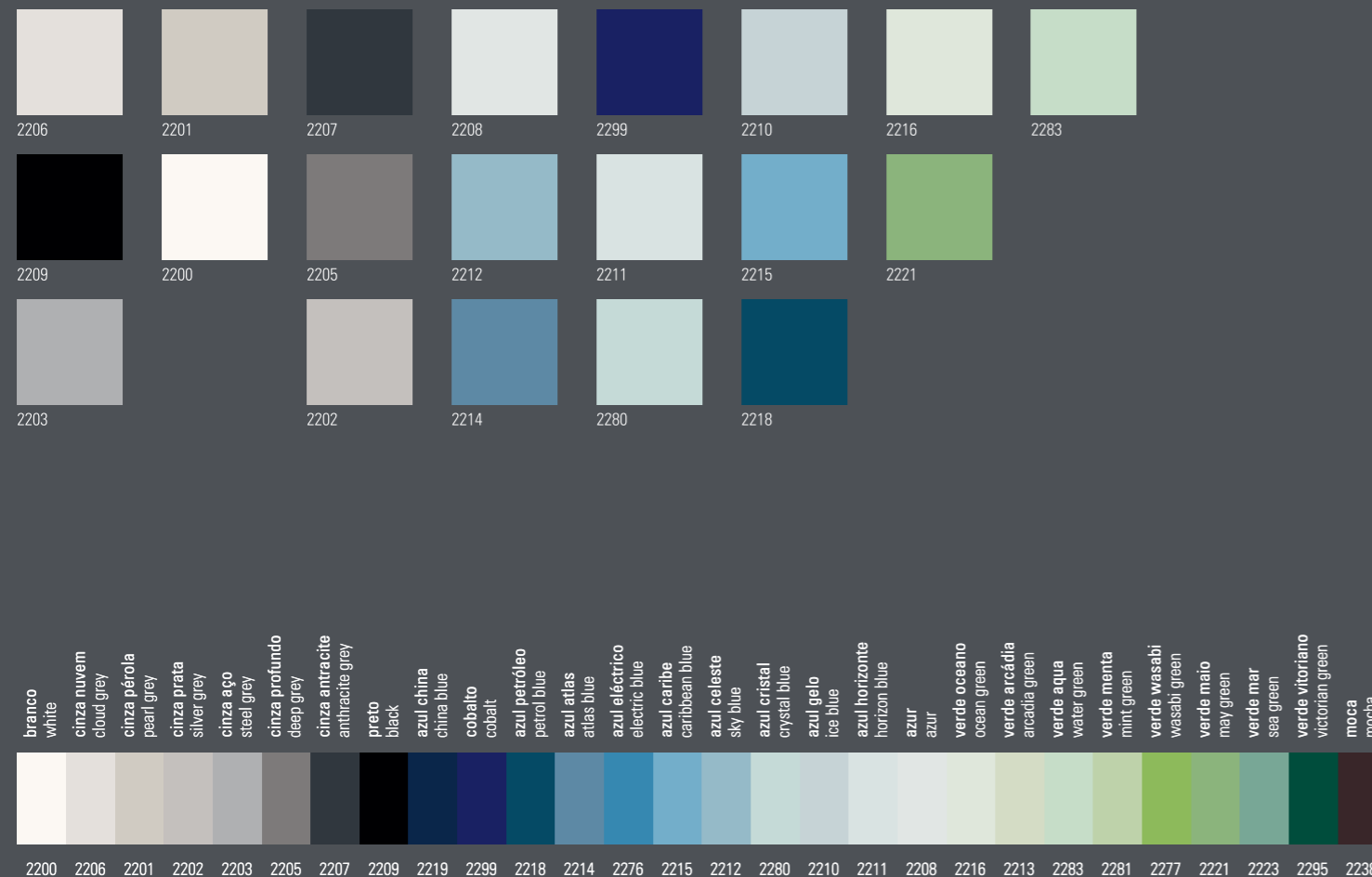

arquitectos

AZULEJOS DE PASTA BRANCA BICOZEDURA MATE · MATT DOUBLE FIRED WHITE BODY WALL TILES
 FAÏENCES EN PÂTE BLANCHE BI-CUISSON MAT · WEISS-SCHERBIGE ZWEIBRAND STEINGUTFLIESEN MATT
 EN 14411: 2012 ANNEX K GROUP BIII GL · ISO 13006: 2012 ANNEX L GROUP BIII GL · ANSI A134.1-2012 CLASS P4 (NON-VITREOUS)



Todos os artigos com a referência sublinhada estão disponíveis em pavimento coordenado (consultar pág. 6 a 19).

All items where the product code is underlined have a matching floor tile (see pages 6 to 19).

Tous les articles soulignés disposent d'un sol coordonné (consulter de la page 6 à la 19).

Die unterstrichenen Artikelnummern sind auch als kombinierbare Bodenfliesen erhältlich (siehe Seite 6 bis 19).

arquitectos	
REF. Brancos · Whites · Blancs · Weiss	
M 20×40 cm	2300 = 0351
M 15×30 cm	

Formato · Format	Caixa · Box			Paleta · Pallet					
	Pcs. · Stk.	m ²	kg	Caixa / Paleta Box / Pallet	m ²	Net. kg	Brut. kg	cm	
Revestimento · Wall Tiles Faïences · Wandfliese	M 20×40×0,75 cm M 15×30×0,75 cm	25 26	2,00 1,17	24,00 14,48	48 70	96,00 81,90	1.152 1.014	1.177 1.039	120×80×96 120×80×91

02 FORMATOS · 02 FORMATS
02 FORMATS · 02 FORMATE

M 20×40 cm
8"×16"
W 197×397×7,5 mm

M 15×30 cm
6"×12"
W 147×297×7,5 mm



31 CORES · 31 COLOURS
31 COLORIS · 31 FARBEN

Cores disponíveis em stock · Colours available in stock
Coloris disponibles en stock · Farben sind Lagerware

2306 2301 2307 2308 2399 2310 2316 2383

2309 2300 2305 2312 2311 2315 2321

2303 2302 2314 2380 2318

branco white
cinza nuvem cloud grey
cinza pérola pearl grey
cinza prata silver grey
cinza aço steel grey
cinza profundo deep grey
cinza antracite anthracite grey
preto black
azul china china blue
cobalto cobalt
azul petróleo petrol blue
azul atlas atlas blue
azul eléctrico electric blue
azul caribe caribbean blue
azul celeste sky blue
azul cristal crystal blue
azul gelo ice blue
azul horizonte horizon blue
azul azul
verde oceano ocean green
verde arcádia arcadia green
verde aqua water green
verde menta mint green
verde wasabi wasabi green
verde malva may green
verde mar sea green
verde victoriano victorian green
moca mocha

2300 2306 2301 2302 2303 2305 2307 2309 2319 2399 2318 2314 ---- 2315 2312 2380 2310 2311 2308 2316 2313 2383 2381 ---- 2321 2323 2395 2338

2342 2324 2320 2398 2317 2388 2397

2322 2387 2340 2359

conhaque cognac
camel camel
sândalo sandal
curry curry
bege bahamas bahamas beige
bege calahari kalahari beige
areia sand
marfim ivory
pérola pearl
creme cream
jasmim jasmine
frésia freesia
baunilha vanilla
amarelo índio indian yellow
amarelo yellow
amarelo ouro gold yellow
âmbar amber
tangerina tangerine
salmão salmon
coral coral
carmim carmine
burgundy burgundy
amaranta amarant
púrpura purple
orquídea orchid
rosa aurora
rosa pétala petal rose
rosa baby baby pink
rosa champagne champagne rose

2337 2370 2343 ---- 2332 2342 2341 2324 2322 2320 2340 2317 ---- 2386 2387 ---- 2398 2388 2372 2359 ---- 2397 ---- 2394 2393 2391 2327 2326 2389

arquitectos

PEÇAS ESPECIAIS · TRIM PIECES · PIÈCES SPÉCIALES · FORMSTÜCKE

AZULEJOS DE PASTA BRANCA BICOZEDURA BRILHANTE/MATE · GLOSSY/MATT DOUBLE FIRED WHITE BODY WALL TILES

FAÏENCE EN PÂTE BLANCHE BI-CUISSON BRILLANT/MAT · WEISS-SCHERBIGE ZWEIBRAND STEINGUTFLIESEN GLÄNZEND/MATT

EN 14411: 2012 ANNEX K GROUP BIII GL · ISO 13006: 2012 ANNEX L GROUP BIII GL · ANSI A134.1-2012 CLASS P4 (NON-VITREOUS)



Disponível em branco brilhante 2200 e mate 2300. Para encomenda de outras cores por favor consultar o fabricante. Devido aos diferentes métodos de produção usados nas peças especiais existe a possibilidade de ocorrer ligeiras variações de cor.

Available in glossy white 2200 and in matt white 2300. For more information on other colours please call us. Due to the methods used in production of tiles and mouldings, slight variations in colour may occur.

Disponible en blanc brillant 2200 et mat 2300. Veuillez consulter le fabricant pour d'autres coloris. De légères variations de couleur sont possibles dû aux différentes méthodes de production utilisées sur ces pièces spéciales.

Erhältlich in Farbe weiß glänzend 2200 und matt 2300. Sollten Sie diese in einer anderen Farbe benötigen wenden Sie sich bitte an unser Verkaufsteam. Produktionsbedingt können leichte Farbunterschiede bzw. Farbabweichungen auftreten.

	Formato · Format	Caixa · Box	
		Pcs. · Stk.	kg
Peças Especiais	3,5×3,5AECX	4	0,07
	3,5×3,5AICV	4	0,07
Pièces Spéciales	15×3,5CV	22	1,89
Trim Pieces	15×3,5CX	22	1,89
Formstücke	20×3,5CV	12	1,41
	20×3,5CX	12	1,41

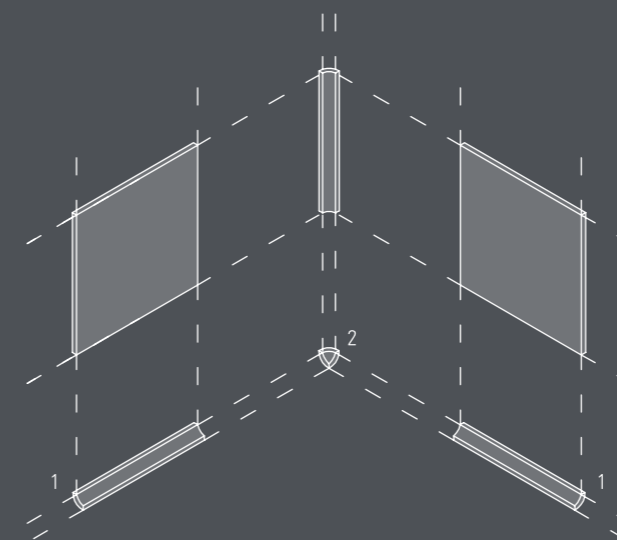
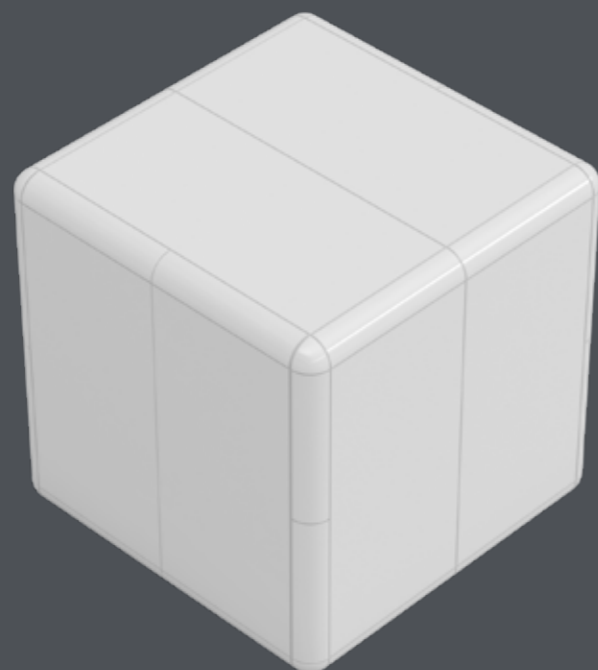
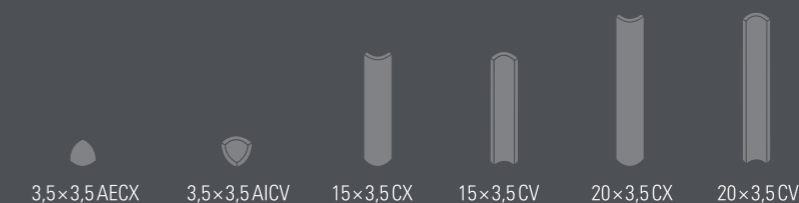

1 - 15×3,5 CV · 2 - 3,5×3,5 AICV

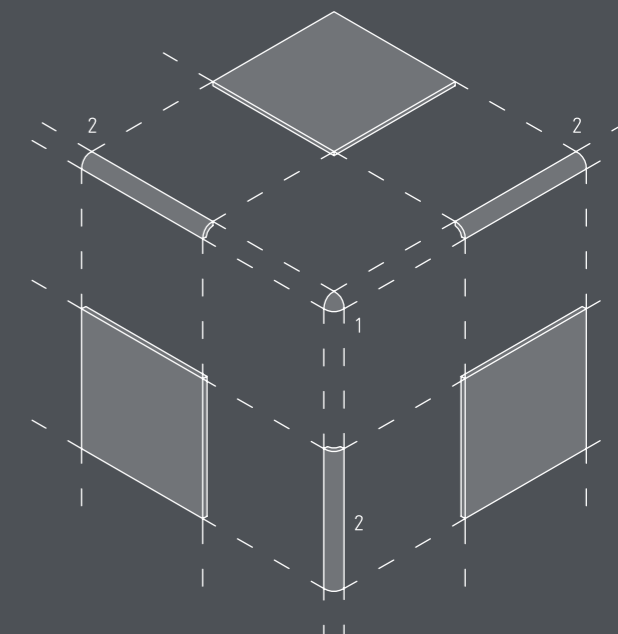

1 - 3,5×3,5 AECX · 2 - 15×3,5 CX



NovaArquitectura & arquitectos

PIANO LISTÉIS · BORDERS · LISTELS · BORDÜREN

AZULEJOS DE PASTA BRANCA BICOZEDURA BRILHANTE · GLOSSY DOUBLE FIRED WHITE BODY WALL TILES
 FAÏENCES EN PÂTE BLANCHE BI-CUISSON BRILLANT · WEISS-SCHERBIGE ZWEIBRAND STEINGUTFLIESEN GLÄNZEND

02 FORMATOS · 02 FORMATS

02 FORMATS · 02 FORMATE

M3×20 cm
 1"×8"
 W 27×197×7,5mm

M3×15 cm
 1"×6"
 W 27×147×5,8mm

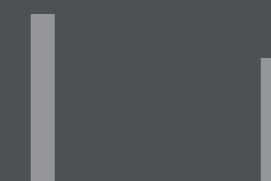

APLICAÇÃO · APPLICATION · APPLICATION · VERLEGUNG
 ACABAMENTO · FINISH · FINITION · OBERFLÄCHE



AZULEJOS DE PASTA BRANCA BICOZEDURA · DOUBLE FIRED WHITE BODY WALL TILES
 FAÏENCES EN PÂTE BLANCHE BI-CUISSON · WEISS-SCHERBIGE ZWEIBRAND STEINGUT

EN 14411: 2012 ANNEX K GROUP BIII GL
 ISO 13006: 2012 ANNEX L GROUP BIII GL
 ANSI A134.1-2012 CLASS P4 (NON-VITREOUS)

21 CORES · 21 COLOURS
 21 COLORIS · 21 FARBEN

BRILHANTE · GLOSSY
 BRILLANT · GLÄNZEND

02 FORMATOS · 02 FORMATS
 02 FORMATS · 02 FORMATE

MODULAR · MODULAR
 MODULAIRE · MODUL

NovaArquitectura & arquitectos

PIANO LISTÉIS · BORDERS · LISTELS · BORDÜREN

AZULEJOS DE PASTA BRANCA BICOZEDURA BRILHANTE · GLOSSY DOUBLE FIRED WHITE BODY WALL TILES

FAÏENCES EN PÂTE BLANCHE BI-CUISSON BRILLANT · WEISS-SCHERBIGE ZWEIBRAND STEINGUTFLIESEN GLÄNZEND

EN 14411: 2012 ANNEX K GROUP BIII GL · ISO 13006: 2012 ANNEX L GROUP BIII GL · ANSI A134.1-2012 CLASS P4 (NON-VITREOUS)



M3×20 cm = 0300/ref.
M3×15 cm = 0200/ref.

CINCA

02 FORMATOS · 02 FORMATS

02 FORMATS · 02 FORMATE

M3×20 cm
1"×8"
W 27×197×7,5 mm

M3×15 cm
1"×6"
W 27×147×5,8 mm

	Formato · Format	Caixa · Box		
		Pcs. · Stk.	ML	kg
Listéis · Listels	M3×20×0,75 cm	30	6,00	1,92
Borders · Bordüren	M3×15×0,58 cm	40	6,00	1,61



21 CORES · 21 COLOURS

21 COLORIS · 21 FARBEN

Cores disponíveis em stock · Colours available in stock

Coloris disponibles en stock · Farben sind Lagerware

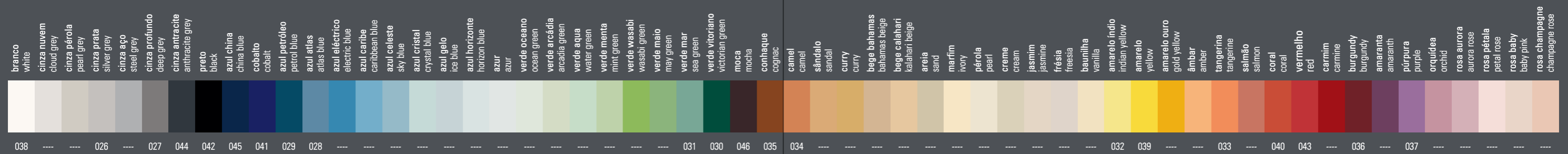
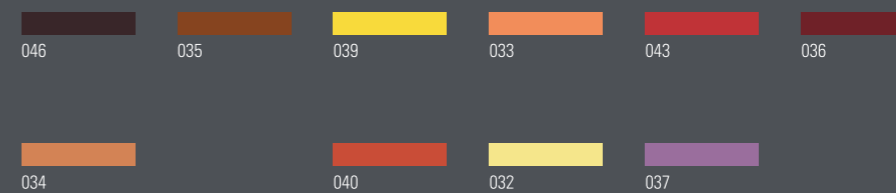
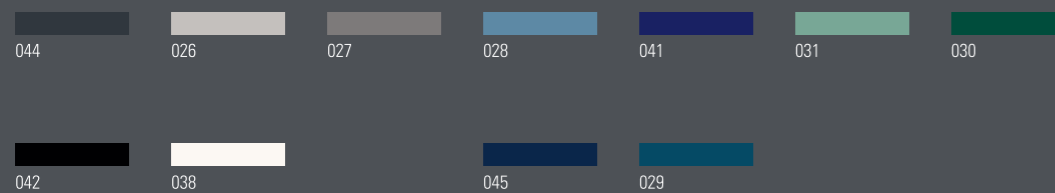

CARACTERÍSTICAS TÉCNICAS · TECHNICAL DATA
CARACTERISTIQUES TECHNIQUES · TECHNISCHE DATEN

CARACTERÍSTICAS TÉCNICAS · CHARACTERISTIQUES TECHNIQUES · TECHNICAL DATA · TECHNISCHE DATEN						
EN 14411: 2012 Anexo H Grupo B1b GL Ladrilhos Vidrados Ingelivos - Carreaux Ingelifs En Grès Fin Vitrifié, Émaillé Frost Resistant Glazed Stoneware Tiles - Frostsichere, Glasierte Steingutfliese						
EN 14411: 2012 Anexo K Grupo B1II GL Azulejos de Pasta Branca Bicozedura - Faïences en Pâte Blanche Bi-cuission Double Fired White Body Wall Tiles - Weiss-Scherbige Zweibrand Steingutfliesen						
Característica / Caractéristique Characteristics / Eigenschaft	Norma Norme Standard Norm	EN	CINCA	EN	CINCA	
Absorção de água (média) Absorption d'eau (moyenne) Water absorption (average) Wasseraufnahme (Durchschnitt)	EN ISO 10545-3	Eb- 10%	18% ≤ Eb<20%	0,5% < Eb< 3,0%	Eb< 1,5%	
Módulo de ruptura (N/mm²) médio Module de rupture (N/mm²) moyenne Modulus of rupture (N/mm²) average Bruchmodul (N/mm²) Durchschnitt	EN ISO 10545-4	> 12N/mm²	20N/mm²	> 30N/mm²	40N/mm²	
Resistência à abrasão superficial Résistance à l'abrasion superficielle Resistance to surface abrasion Oberflächenverschleissbeständigkeit	EN ISO 10545-7	-	-	Classe de Abrasão	(1)	
Resistência ao choque térmico Résistance aux chocs de température Thermal shock resistance Temperaturwechselbeständigkeit	EN ISO 10545-9	Exigida Exigée Required Gefordert	Conforme Conforme Conforms Entspricht	Exigida Exigée Required Gefordert	Conforme Conforme Conforms Entspricht	
Resistência à fendilhagem Résistance au tressillage Tensile strength Haftbeständigkeit	EN ISO 10545-11	Exigida Exigée Required Gefordert	Conforme Conforme Conforms Entspricht	Exigida Exigée Required Gefordert	Conforme Conforme Conforms Entspricht	
Resistência ao gelo Résistance au gel Frost resistance Frostbeständigkeit	EN ISO 10545-12	Valor declarado Valeur déclarée Declared value Angegebener Wert	Não Non No Nein	Exigida Exigée Required Gefordert	Conforme Conforme Conforms Entspricht	
Resistência de colagem – cimentos cola tipo C2 Résistance du collage – ciment colle Bond strength – cementitious adhesives Klebebeständigkeit – Klebemörtel	EN 12004 4.1	Valor declarado Valeur déclarée Declared value Angegebener Wert	> 1 N/mm²	Valor declarado Valeur déclarée Declared value Angegebener Wert	> 1 N/mm²	
Resistência de colagem – colas em dispersão aquosa tipo D1 Résistance du collage – colles dispersées aqueuses Bond strength – dispersion adhesives Klebebeständigkeit – wasserlöslicher Kleber	EN 12004 4.2	Valor declarado Valeur déclarée Declared value Angegebener Wert	> 1 N/mm²	Valor declarado Valeur déclarée Declared value Angegebener Wert	> 1 N/mm²	
Resistência de colagem – colas de resinas de reação tipo R2 Résistance du collage – colles de résines de réaction Bond strength – reaction resin adhesives Klebebeständigkeit – Reaktionsharzkleber	EN 12004 4.3	Valor declarado Valeur déclarée Declared value Angegebener Wert	> 2 N/mm²	Valor declarado Valeur déclarée Declared value Angegebener Wert	> 2 N/mm²	
Resistência de colagem – argamassas de reboco Résistance du collage – mortars pour maçonnerie Bond strength – mortar Klebebeständigkeit – Mörtel für Mauerwerk	EN 1015-12	Valor declarado Valeur déclarée Declared value Angegebener Wert	NPD	Valor declarado Valeur déclarée Declared value Angegebener Wert	NPD	
Resistência ao impacto (coeficiente de restituição) Résistance au choc (coefficient de restitution) Impact resistance (restitution coefficient) Impaktbeständigkeit	EN ISO 10545-5	-	-	Valor declarado Valeur déclarée Declared value Angegebener Wert	> 0,55	
Reação ao fogo (2) Réaction au feu Reaction to fire Reaktion auf Feuer	CWT	Class A1	Class A1	Class A1	Class A1 / A1 _n	
Tactilidade Tactilité Tastgefühl	CEN/TS 15399	-	-	Declarar superficie Déclarer surface Oberfläche angeben	NPD	
Resistência às manchas Résistance aux taches Stain resistance Fleckenbeständigkeit	EN ISO 10545-14	Min. Class 3	Class 5	Min. Class 3	Class 5	
Fracos concentrações de ácidos e bases Basses concentrations d'acides et de bases Low acid and base concentrations Niedrige Konzentrationen von Säuren und Laugen	EN ISO 10545-13	Valor declarado Valeur déclarée Declared value Angegebener Wert	GLA	Valor declarado Valeur déclarée Declared value Angegebener Wert	GLA	
Produtos de limpeza e aditivos de piscinas Produits de nettoyage et additifs pour eau de piscine Household chemicals and swimming pool additives Reinigungsprodukte und Wasserzusatz für Schwimmbäder	EN ISO 10545-13	Min. Class B	GA	Min. Class B	GA	
Libertação de cádmio e chumbo (3) (4) Dépagement de cadmium et plomb Release of cadmium and lead Abgabe von Cadmium und Blei	EN ISO 10545-15	Valor declarado Valeur déclarée Angegebener Wert	NPD	Valor declarado Valeur déclarée Angegebener Wert	NPD	

CARACTERÍSTICAS TÉCNICAS · TECHNICAL DATA
CARACTERISTIQUES TECHNIQUES · TECHNISCHE DATEN

CARACTERÍSTICAS TÉCNICAS · CHARACTERISTIQUES TECHNIQUES · TECHNICAL DATA · TECHNISCHE DATEN						
EN 14411: 2012 Anexo H Grupo B1b GL Ladrilhos Vidrados Ingelivos - Carreaux Ingelifs En Grès Fin Vitrifié, Émaillé Frost Resistant Glazed Stoneware Tiles - Frostsichere, Glasierte Steingutfliese						
EN 14411: 2012 Anexo K Grupo B1II GL Azulejos de Pasta Branca Bicozedura - Faïences en Pâte Blanche Bi-cuission Double Fired White Body Wall Tiles - Weiss-Scherbige Zweibrand Steingutfliesen						
Característica / Caractéristique Characteristics / Eigenschaft	Norma Norme Standard Norm	EN	CINCA	EN	CINCA	
Qualidade de superfície Qualité de la surface Surface quality Oberfläche	EN ISO 10545-2	> 95%	> 95%	> 95%	> 95%	
Desvio da dimensão de fabrica (W) Écart de la dimension de fabrication (W) Deviation from work size (W) Abweichung zum Produktionsmaß (W)	EN ISO 10545-2	± 0,5%	± 0,3%	± 0,6%	± 0,3%	
Espessura Épaisseur Thickness Stärkegenauigkeit	EN ISO 10545-2	± 10%	± 5%	± 5%	± 5%	
Rectilinearidade das arestas Rectilignité des arêtes Straightness of edges Kantengeradigkeit	EN ISO 10545-2	± 0,3%	± 0,15%	± 0,5%	± 0,25%	
Angularidade Angularité Rectangularity Rechtwinkligkeit	EN ISO 10545-2	± 0,5%	± 0,25%	± 0,5%	± 0,25%	
Planaridade (curvatura central) Planéité (courbure au centre) Planarity (central dome) Planarität (Mittelpunktswölbung)	EN ISO 10545-2	+ 0,5% - 0,3%	+ 0,25% - 0,15%	± 0,5%	± 0,25%	
Planaridade (curvatura lateral de aresta) Planéité (courbure des arêtes) Planarity (ledge dome) Planarität (Kantenswölbung)	EN ISO 10545-2	+ 0,5% - 0,3%	+ 0,25% - 0,15%	± 0,5%	± 0,25%	
Planaridade (empeno na diagonal) Planéité (vrillage par rapport à la diagonale) Planarity (skew) Planarität (Windschiefe)	EN ISO 10545-2	± 0,5%	± 0,25%	± 0,5%	± 0,25%	

RESISTÊNCIA AO DESLIZAMENTO · RÉSISTANCE À LA GLISSANCE · SLIP RESISTANCE CHART · TRITTSICHERHEIT				
DIN 51130 / S1097				
Característica / Caractéristique Characteristics / Eigenschaft	DIN	Éris Vidrado Grès Émaillé Sol / Mir Glazed Stoneware Floor / Wall Tiles Glasiertes Steinzeug / Wand&Böden	Éris Vidrado Antideslizante Grès Émaillé Sol Antidérapant Anti-slip Glazed Stoneware Floor Tiles Glasiertes Steinzeug / Boden Rutschfest	
Resistência ao deslizamento (pé descalço) Résistance à la glissance (pieds nus) Slip resistance (barefoot) Rutschkoeffizient (Barfußbereich)	S1097	NPD	B	
Resistência ao deslizamento (pé calçado) Résistance à la glissance (pieds chaussés) Slip resistance (with footwear) Rutschkoeffizient (mit Schuhen)	S1130	NPD	B11	

(1) Consultar o fabricante / Consulter le fabricant / Please contact manufacturer / Hersteller kontaktieren. (2) Os ladrilhos cerâmicos não contribuem para o fogo e são considerados materiais da Classe A1 (CWT Decisão 96/603/CE) / Les carreaux en céramique ne brûlent pas et sont Classe A1 (CWT Décision 96/603/CE) / Ceramic tiles does not contribute to fire and are considered a Class A1 material (CWT Decision 96/603/CE) / Die Keramikfliesen sind nicht Brand fördernd und werden als Material der Klasse A1 eingestuft (CWT Entscheidung 96/603/CE). (3) Quando os produtos se destinem a ser usados em locais onde ocorre a preparação de alimentos e onde estejam em contacto directo com a superfície vidrada, valores indicativos que podem ser alterados sem aviso prévio / Pour produits destinés à être utilisés dans des zones de préparation de produits alimentaires et où ceux-ci sont en contact direct avec la surface émaillée, valeurs indicatives qui peuvent être changées sans avis préalable / Only when intended to use in places where food preparation takes place and food may be in direct contact with the glazed surface of the tile. Indicative figures subject to changes without further notice / Falls die Produkte dafür bestimmt sind, auf Arbeitsflächen oder Wänden benutzt zu werden, in Räumen in denen Lebensmittel verarbeitet werden und diese in direktem Kontakt zur Glasierung kommen. Es handelt sich hierbei um Richtwerte, die ohne Vorankündigung geändert werden können. (4) Para outras substâncias perigosas, apenas serão realizados ensaios a pedido do cliente, quando relevante considerando regulamentos europeus ou leis, regulamentos ou provisos administrativos / Pour autres substances dangereuses, les tests seront seulement réalisés sur demande du client, s'ils s'avèrent pertinents face aux réglementations européennes ou face aux lois, règlements et dispositions administratives / For other dangerous substances, tests will only be conducted when relevant and requested from customers, considering european regulations or national laws, regulations or administrative provisions / Für andere gefährliche Substanzen werden die Prüfungen nur auf Kundenwunsch durchgeführt, falls relevant, und unter Beachtung der europäischen Vorschriften oder Gesetze, Verordnungen oder Verwaltungsvorschriften. Contatar a CINCA para mais informações / Contacter CINCA pour plus d'informations / Please contact CINCA for more informations / Für weitere Informationen bitte CINCA kontaktieren.

AVISO / AVIS / DISCLAIMER / WAARNING: Especificações sujeitas a alterações sem aviso prévio. A presente informação é fornecida sem qualquer garantia adicional de adequação à qualquer uso específico. Em nenhum caso a CINCA poderá ser responsabilizada por qualquer dano direto, indireto ou consequente decorrente de, ou de qualquer forma relacionado com, o uso dos seus produtos / Specifications soumises à modifications sans avis préalable. La présente information est fournie sans aucune garantie supplémentaire d'adaptation à n'importe quelle utilisation spécifique. En aucun cas CINCA ne pourra être responsable pour n'importe quel dégat direct, indirect, résultant ou lié à l'utilisation de ses produits / Specifications subject to change without further notice. This information is issued as is and without any further warranty of fitness for a particular purpose, so in no event shall CINCA be liable for any direct, indirect, or consequential damage whatsoever arising out of or in any way related to the use of their product / Angaben können ohne Bekanntgebung geändert werden. Diese Informationen werden ohne jegliche Gewährleistung der Eignung für einen bestimmten Zweck zur Verfügung gestellt. In keinem Fall darf CINCA haftbar gemacht werden für direkte, indirekte oder in jeglicher Form stehenden Zusammenhang mit Schäden oder Folgeschäden durch die Verwendung seiner Produkte.

CARACTERÍSTICAS TÉCNICAS · TECHNICAL DATA
CARACTERISTIQUES TECHNIQUES · TECHNISCHE DATEN

EMBALAGENS E PESOS · EMBALLAGES ET POIDS · PACKING AND WEIGHTS · VERPACKUNGEN UND GEWICHTE										
Formato · Format	Caixa · Box			Paleta · Pallet						
	Pcs. / Stk.	m² / ML	kg	Caixa / Paleta Box / Pallet	m²	Net. kg	Brut. kg	cm		
Pavimento Carreaux de Sol Floor Tiles Bodenfliese	M 60×60×1 cm	3	1,08 m²	24,30	36	38,88	875	900	120×80×74	
	M 30×30×0,7 cm	15	1,35 m²	20,15	50	67,50	1.008	1.033	120×80×73	
	M 10×30×0,7 cm	50	1,50 m²	21,80	48	72,00	1.046	1.071	120×80×73	
	M 20×20×0,6 cm	25	1,00 m²	12,64	84	84,00	1.062	1.087	120×80×73	
	M 15×15×0,6 cm	44	1,00 m²	12,34	80	80,00	987	1.012	120×80×73	
	M 10×20×0,6 cm	50	1,00 m²	12,77	84	84,00	1.073	1.098	120×80×74	
M 10×10×0,6 cm	99	1,00 m²	12,50	78	78,00	975	1.000	120×80×82		
Peças Especiais Pièces Spéciales Trim Pieces Formstücke	3×3AECX	4	-	0,10	-	-	-	-	-	
	3×3AICX	4	-	0,10	-	-	-	-	-	
	3×3AICV	4	-	0,10	-	-	-	-	-	
	3×3AE	4	-	0,10	-	-	-	-	-	
	10×3AE	4	-	0,30	-	-	-	-	-	
	10×3AI	4	-	0,20	-	-	-	-	-	
	15×3AI	4	-	0,40	-	-	-	-	-	
	15×3AE	4	-	0,40	-	-	-	-	-	
	15×3CV	25	-	1,88	-	-	-	-	-	
	15×3CX	25	-	1,88	-	-	-	-	-	
	20×3CV	25	-	2,25	-	-	-	-	-	
	20×3CX	25	-	2,25	-	-	-	-	-	
	10×20RC	10	2,00 ML	3,30	-	-	-	-	-	
	10×20BIG	50	1,00 m²	13,50	-	-	-	-	-	
	10×20B1P	50	1,00 m²	13,50	-	-	-	-	-	
	10×20B2E	50	1,00 m²	13,50	-	-	-	-	-	
10×20B2D	50	1,00 m²	13,50	-	-	-	-	-		
15×15RC	10	1,50 m²	3,30	-	-	-	-	-		
15×15B1L	44	1,00 m²	12,80	-	-	-	-	-		
15×15LC	10	1,50 m²	3,30	-	-	-	-	-		
15×15CC	4	-	1,50	-	-	-	-	-		
20×20B1L	25	1,00 m²	12,70	-	-	-	-	-		
20×20B2L	25	1,00 m²	12,70	-	-	-	-	-		
8×6ROD	20	12,00 ML	21,40	-	-	-	-	-		
Revestimento Faïences Wall Tiles Wandfliese	M 20×40×0,75 cm	25	2,00 m²	24,00	48	96,00	1.152	1.177	120×80×96	
	M 15×30×0,75 cm	26	1,17 m²	14,48	70	81,90	1.014	1.039	120×80×91	
	M 20×20×0,75 cm	25	1,00 m²	12,00	96	96,00	1.152	1.177	120×80×95	
M 15×15×0,58 cm	36	1,50 m²	13,97	70	105,00	978	1.003	120×80×90		
Listéis · Listels Borders · Bordüren	M 3×20×0,75 cm	60	6,00 ML	1,92	-	-	-	-	-	
	M 3×15×0,58 cm	40	6,00 ML	1,61	-	-	-	-	-	
Peças Especiais Pièces Spéciales Trim Pieces Formstücke	3,5×3,5AECX	4	0,07	-	-	-	-	-	-	
	3,5×3,5AICV	4	0,07	-	-	-	-	-	-	
	15×3,5CV	22	1,89	-	-	-	-	-	-	
	15×3,5CX	22	1,89	-	-	-	-	-	-	
	20×3,5CV	12	1,41	-	-	-	-	-	-	
	20×3,5CX	12	1,41	-	-	-	-	-	-	

Copyright Cinca (P) (G) 2015 - Developed by the Cinca Marketing Department - Printed by Glacia AG



Certificação ISO 14001 do Sistema de Gestão do Ambiente
Implementado na Concepção, Desenvolvimento, Produção e Comercialização de Pavimentos e Revestimentos Cerâmicos



Certificação ISO 9001 do Sistema de Gestão da Qualidade
Implementado na Concepção, Desenvolvimento, Produção e Comercialização de Pavimentos e Revestimentos Cerâmicos



Certificação de Qualidade de Revestimentos Cerâmicos
Wall Tiles Quality Certification



CERAMICS®
Portugal does it better



Certificação ISO 9001 do Sistema de Gestão da Qualidade
Implementado na Concepção, Desenvolvimento, Produção e Comercialização de Pavimentos e Revestimentos Cerâmicos



Certificação de Qualidade de Pavimentos Cerâmicos
Floor Tiles Quality Certification



NCS - Natural Colour System®
property of and used on licence from NCS Colour AB, Stockholm 2012. The colours might not exactly match original NCS colour samples.

CINCA S.A.

Rua Principal, 39 | Apartado 12
P 4509-908 Fiães VFR Portugal
Tel.: 227 476 400
Fax: 227 476 488
Email: cinca@cinca.pt

Export Department

Rua Principal, 39 | Apartado 12
P 4509-908 Fiães VFR Portugal
Tel.: +351 227 476 462
Fax: +351 227 476 494/5
Email: internacional@cinca.pt

Serviços Comerciais Portugal

Rua Principal, 39 | Apartado 12
P 4509-908 Fiães VFR Portugal
Tel.: 227 476 404
Fax: 227 476 490
Email: portugal@cinca.pt

Showroom Lisboa

Rua Abranches Ferrão, 3B
P 1600-296 Lisboa Portugal
Tel.: 217 210 620
Fax: 217 210 629

Showroom Porto

Edifício Mota Galiza
Rua Calouste Gulbenkian, 161
P 4050-145 Porto Portugal
Tel.: 227 476 489
Fax: 226 062 502

www.cinca.pt

